

DENON

Hi-Fi Pre-Main Amplifier

SERVICE MANUAL

MODEL PMA-1060/860

INTEGRATED STEREO AMPLIFIER

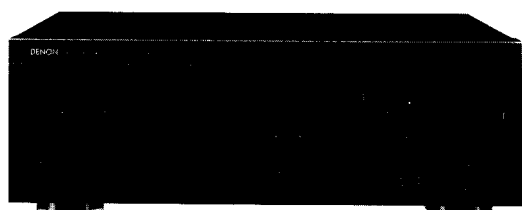

PMA-1060



PMA-860

CONTENTS

OPERATING INSTRUCTIONS	2 ~ 10
BLOCK, LEVEL DIAGRAM	11
METHOD OF ADJUSTMENTS	12
REMOVAL OF EACH SECTION	13
SEMICONDUCTORS	14
PRINTED WIRING BOARD	
P.AMP & SUPPLY UNIT (FOR PMA-1060)	14
POWER SWITCH UNIT (FOR PMA-1060)	14
INPUT & CONTROL UNIT (FOR PMA-1060)	15
INPUT & CONTROL UNIT (FOR PMA-860)	16
P.AMP & SUPPLY UNIT (FOR PMA-860)	17
POWER SWITCH UNIT (FOR PMA-860)	17
NOTE FOR PARTS LIST	18
PRINTED WIRING BOARD PARTS LIST	19 ~ 27
PARTS LIST OF EXPLODED VIEW	28 ~ 30
EXPLODED VIEW OF CHASSIS AND CABINET	31
WIRING DIAGRAM	32
SCHEMATIC DIAGRAM	
PMA-1060	33
PMA-860	34

NIPPON COLUMBIA CO., LTD.

EXCEPT U.K. & AUSTRALIA MODELS

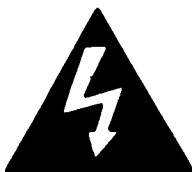
**CAUTION**

**RISK OF ELECTRIC SHOCK
DO NOT OPEN**



CAUTION: TO REDUCE THE RISK OF ELECTRIC SHOCK, DO NOT REMOVE COVER (OR BACK). NO USER SERVICE-ABLE PARTS INSIDE. REFER SERVICING TO QUALIFIED SERVICE PERSONNEL.



The lightning flash with arrowhead symbol, within an equilateral triangle, is intended to alert the user to the presence of uninsulated "dangerous voltage" within the product's enclosure that may be of sufficient magnitude to constitute a risk of electric shock to persons.



The exclamation point within an equilateral triangle is intended to alert the user to the presence of important operating and maintenance (servicing) instructions in the literature accompanying the appliance.

WARNING: TO REDUCE THE RISK OF FIRE OR ELECTRIC SHOCK, DO NOT EXPOSE THIS APPLIANCE TO RAIN OR MOISTURE.

CAUTION

TO PREVENT ELECTRIC SHOCK DO NOT USE THIS (POLARIZED) PLUG WITH AN EXTENSION CORD, RECEPTACLE OR OTHER OUTLET UNLESS THE BLADES CAN BE FULLY INSERTED TO PREVENT BLADE EXPOSURE.

ATTENTION

POUR PREVENIR LES CHOCS ELECTRIQUES NE PAS UTILISER CETTE FICHE POLARISEE AVEC UN PROLONGATEUR UNE PRISE DE COURANT OU UNE AUTRE SORTIE DE COURANT, SAUF SI LES LAMES PEUVENT ETRE INSEREES A FOND SANS EN LAISSER AUCUNE PARTIE A DECOUVERT.

SAFETY INSTRUCTIONS

1. Read Instructions – All the safety and operating instructions should be read before the appliance is operated.
2. Retain Instructions – The safety and operating instructions should be retained for future reference.
3. Heed Warnings – All warnings on the appliance and in the operating instructions should be adhered to.
4. Follow Instructions – All operating and use instructions should be followed.
5. Water and Moisture – The appliance should not be used near water – for example, near a bathtub, washbowl, kitchen sink, laundry tub, in a wet basement, or near a swimming pool, and the like.
6. Carts and Stands – The appliance should be used only with a cart or stand that is recommended by the manufacturer.
- 6A. An appliance and cart combination should be moved with care. Quick stops, excessive force, and uneven surfaces may cause the appliance and cart combination to overturn.
7. Wall or Ceiling Mounting – The appliance should be mounted to a wall or ceiling only as recommended by the manufacturer.
8. Ventilation – The appliance should be situated so that its location or position does not interfere with its proper ventilation. For example, the appliance should not be situated on a bed, sofa, rug, or similar surface that may block the ventilation openings; or, placed in a built-in installation, such as a bookcase or cabinet that may impede the flow of air through the ventilation openings.
9. Heat – The appliance should be situated away from heat sources such as radiators, heat registers, stoves, or other appliances (including amplifiers) that produce heat.



10. Power Sources – The appliance should be connected to a power supply only of the type described in the operating instructions or as marked on the appliance.
11. Grounding or Polarization – The precautions that should be taken so that the grounding or polarization means of an appliance is not defeated.
12. Power-Cord Protection – Power-supply cords should be routed so that they are not likely to be walked on or pinched by items placed upon or against them, paying particular attention to cords at plugs, convenience receptacles, and the point where they exit from the appliance.
13. Protective Attachment Plug – The appliance is equipped with an attachment plug having overload protection. This is a safety feature. See Instruction Manual for replacement or resetting of protective device. If replacement of the plug is required, be sure the service technician has used a replacement plug specified by the manufacturer that has the same overload protection as the original plug.
14. Cleaning – The appliance should be cleaned only as recommended by the manufacturer.
15. Power Lines – An outdoor antenna should be located away from power lines.
16. Outdoor Antenna Grounding – If an outside antenna is connected to the receiver, be sure the antenna system is grounded so as to provide some protection against voltage surges and built up static charges. Section 810 of the National Electrical Code, ANSI/NFPA No. 70–1984, provides information with respect to proper grounding of the mast and support-
 ing structure, grounding of the lead-in wire to an antenna discharge unit, size of grounding conductors, location of antenna-discharge unit, connection to grounding electrodes, and requirements for the grounding electrode. See Figure A.
17. Nonuse Periods – The power cord of the appliance should be unplugged from the outlet when left unused for a long period of time.
18. Object and Liquid Entry – Care should be taken so that objects do not fall and liquids are not spilled into the enclosure through openings.
19. Damage Requiring Service – The appliance should be serviced by qualified service personnel when:
 - A. The power-supply cord or the plug has been damaged; or
 - B. Objects have fallen, or liquid has been spilled into the appliance; or
 - C. The appliance has been exposed to rain; or
 - D. The appliance does not appear to operate normally or exhibits a marked change in performance; or
 - E. The appliance has been dropped, or the enclosure damaged.
20. Servicing – The user should not attempt to service the appliance beyond that described in the operating instructions. All other servicing should be referred to qualified service personnel.

FIGURE A
EXAMPLE OF ANTENNA GROUNDING ACCORDING
TO NATIONAL ELECTRICAL CODE INSTRUCTIONS
CONTAINED IN ARTICLE 810 – "RADIO AND
TELEVISION EQUIPMENT"

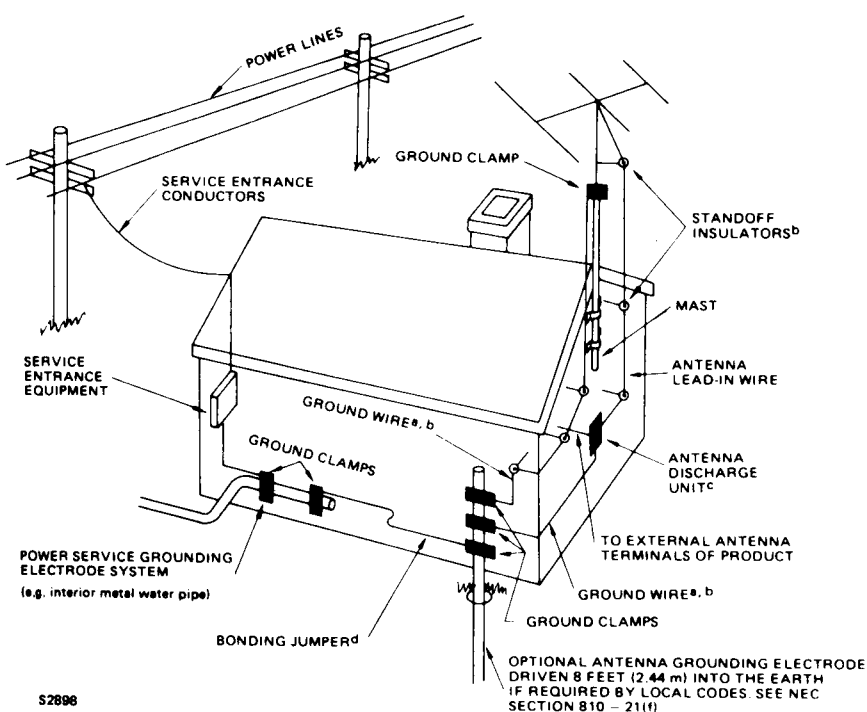

- a Use No. 10 AWG (5.3 mm²) copper, No. 8 AWG (8.4 mm²) aluminum, No. 17 AWG (1.0 mm²) copper-clad steel or bronze wire, or larger, as a ground wire.
- b Secure antenna lead-in and ground wires to house with stand-off insulators spaced from 4–6 feet (1.22–1.83 m) apart.
- c Mount antenna discharge unit as close as possible to where lead-in enters house.
- d Use jumper wire not smaller than No. 6 AWG (13.3 mm²) copper, or the equivalent, when a separate antenna grounding electrode is used. See NEC Section 810-21 (j).

S2898

For United Kingdom model only.

WARNING:

As the colours of the wires in the mains lead of this appliance may not correspond with the coloured markings identifying the terminals in your plug proceed as follows:

The wire which is coloured blue must be connected to the terminal which is marked with the letter N or coloured black.

The wire which is coloured brown must be connected to the terminal which is marked with the letter L or coloured red.

IMPORTANT

The wires in this mains lead are coloured in accordance with the following code:

Blue: Neutral
Brown: Live

Die Deutsche Bundespost informiert

Sehr geehrter Rundfunkteilnehmer,

Dieses Gerät ist von der Deutschen Bundespost als Ton- bzw. Fernseh-Rundfunkempfänger bzw. als Komponente einer solchen Anlage (Tuner, Verstärker, aktive Lautsprecherbox, Fernseh-Monitor u. dgl.) zugelassen, es entspricht den zur Zeit geltenden Technischen Vorschriften und ist zum Nachweis dafür mit dem Zulassungszeichen der Deutschen Bundespost gekennzeichnet. Bitte überzeugen Sie sich selbst. Dieses Gerät darf im Rahmen der "Allgemeineingenehmigung für das Errichten und Betreiben von Ton- und Fernseh-Rundfunkempfängern" in der Bundesrepublik Deutschland betrieben werden. Beachten Sie aber bitte, daß aufgrund dieser Genehmigung nur für die Allgemeinheit bestimmte Sendungen und solche, für die ebenfalls eine Allgemeine Empfangsgenehmigung erteilt worden ist^{*)}, empfangen und wiedergegeben werden dürfen. Wer unbefugt andere Sendungen (z. B. des Polizeifunks, des Mobilfunks) empfängt und wiedergibt, verstößt gegen die Genehmigungsaufgaben und macht sich daher nach § 15, Absatz 2a des Gesetzes über Fernmeldeanlagen strafbar.

Die Kennzeichnung mit dem Zulassungszeichen bietet Ihnen die Gewähr, daß dieses Gerät keine anderen die Kennzeichnung mit dem Zulassungszeichen bietenden elektrischen Anlagen stört. Der Zusatzbuchstabe S^{**)} beim Zulassungszeichen besagt außerdem, daß das Gerät gegen störende Beeinflussungen durch andere ordnungsgemäß errichtete und betriebene elektrische Anlagen weitgehend unempfindlich ist. Geräte ohne den Zusatz S sind nicht besonders sicher gegen Beeinflussungen.

Sollten bei Geräten mit dem Zusatz S ausnahmsweise trotzdem Beeinflussungen auftreten, oder wenn Sie Fragen haben, so wenden Sie sich bitte an die örtlich zuständige Funkstörungsmeßstelle.

^{*)} Zur Zeit für den Empfang der Aussendungen von Amateurfunkstellen und der Normal Frequenz- und Zeitzeichensendungen.

^{**)} Weitere Zusätze haben in Bezug auf die Störfestigkeit keine Bedeutung. Sie geben bei Empfängern vielmehr Aufschluß über Empfangsmöglichkeiten.

Allgemeine Genehmigung für Ton- und Fernseh-Rundfunkempfänger

Die Allgemeine Ton- und Fernseh-Rundfunkgenehmigung vom 11.12.1970 (veröffentlicht im Bundesanzeiger Nr. 234 vom 16.12.1970) wird unter Bezug auf Abschnitt III der Genehmigung durch folgende Fassung der Allgemeinen Genehmigung für Ton- und Fernseh-Rundfunkempfänger gemäß den §§ 1 und 2 des Gesetzes über Fernmeldeanlagen ersetzt:

Genehmigung für Ton- und Fernseh-Rundfunkempfänger

1 Die Errichtung und der Betrieb von Ton- und Fernseh-Rundfunkempfängern werden nach §§ 1 und 2 des Gesetzes über Fernmeldeanlagen in der Fassung der Bekanntmachung vom 17.3.1977 (BGBl. I, S. 459) allgemein genehmigt.

2 Ton- und Fernseh-Rundfunkempfänger im Sinne dieser Genehmigung sind Funkanlagen gemäß § 1 Abs. 1 des Gesetzes über Fernmeldeanlagen, die ausschließlich die für Rundfunkempfänger zugelassenen Frequenzbereiche^{*)} aufweisen und zum Aufnehmen und gleichzeitigen Hör- oder Sichtbarmachen von Ton- oder Fernseh-Rundfunksendungen bestimmt sind. Zum Empfänger gehören auch eingebaute oder mit ihm fest verbundene Antennen sowie bei Unterteilung in mehrere Geräte die funktionsmäßig zugehörigen Geräte. Außer für den Empfang von Rundfunksendungen dürfen Ton- und Fernseh-Rundfunkempfänger nur mit besonderer Genehmigung der Deutschen Bundespost für andere Fernmeldezwecke zusätzlich benutzt werden. In den Empfängern eingebaute oder sonst mit ihm verbundene Zusatzgeräte (z. B. Ultraschallfernmeldeanlagen, in den Empfängern eingebaute oder sonst mit ihm verbundene Zusatzgeräte (z. B. Ultraschallfernmeldeanlagen, in den Empfängern eingebaute oder sonst mit ihm verbundene Zusatzgeräte) werden von dieser Genehmigung nicht erfaßt (ausgenommen die Einrichtungen zum Empfang des Verkehrsfunkts). Desgleichen sind andere technische Empfangereigenschaften, die über den eigentlichen Zweck eines Rundfunkempfängers hinausgehen (z. B. zum Empfang anderer Funkdienste, für die Wiedergabe im Rahmen von Textübertragungsverfahren) hierdurch nicht genehmigt. Hierfür gelten besondere Regelungen.

Diese Genehmigung wird unter nachstehenden Auflagen erteilt:

1. Ton- und Fernseh-Rundfunkempfänger müssen den jeweils geltenden Technischen Vorschriften für Ton- und Fernseh-Rundfunkempfänger entsprechen. Eingebaute Zusatzgeräte müssen den für sie geltenden Bestimmungen und technischen Vorschriften genügen. Änderungen der Technischen Vorschriften, die im Amtsblatt des Bundesministers für das Post- und Fernmeldewesen veröffentlicht werden, muß bei schon errichteten und in Betrieb genommenen Ton- und Fernseh-Rundfunkempfängern nachgekommen werden, wenn durch den Betrieb dieser Rundfunkempfänger andere elektrische Anlagen gestört werden. Serienmäßig hergestellte Ton- und Fernseh-Rundfunkempfänger müssen zum Nachweis dafür, daß sie den

^{*)} Siehe Technische Vorschriften für Ton- und Fernseh-Rundfunkempfänger, veröffentlicht im Amtsblatt des Bundesministers für das Post- und Fernmeldewesen.
^{**)} Für ausnahmsweise noch nicht gekennzeichnete, vor dem 1.7.1979 errichtete und in Betrieb genommene Ton-Rundfunkempfänger wird die Kennzeichnung nicht verlangt.

Technischen Vorschriften entsprechen, mit einer DBP-Prüfnummer gekennzeichnet sein. ^{**)} Die DBP-Prüfnummer sagt über die elektrische und mechanische Sicherheit und die Einhaltung der Strahlenschutzbestimmungen nichts aus.

2. Ton- und Fernseh-Rundfunkempfänger dürfen an ortsfesten oder nichtortsfesten Rundfunk-Empfangsantennenanlagen, Verteilanlagen oder Kabelfernsehanlagen betrieben und im Rahmen der Bestimmungen über private Drahtfernmeldeanlagen mit Drahtfernmeldeanlagen verbunden werden. Auf demselben Grundstück oder innerhalb eines Fahrzeuges dürfen Ton- und Fernseh-Rundfunkempfänger mit anderen Geräten oder sonstigen Gegenständen (z. B. Plattenspieler, Magnetaufzeichnungs- und Wiedergabegeräte, Antennen) verbunden werden, sofern diese Geräte von der Deutschen Bundespost genehmigt sind oder keiner Genehmigung bedürfen. Die räumliche Kombination von Funkanlagen mit Ton- oder Fernseh-Rundfunkempfängern ist nur dann zulässig, wenn die betreffenden Funkanlagen je für sich genehmigt sind.
3. Mit Ton- oder Fernseh-Rundfunkempfängern dürfen aufgrund dieser Genehmigung nur Sendungen des Rundfunks empfangen werden, also übertragene Tonsignale (Musik, Sprache) und Fernsehsignale (nur Bildinformationen). Andere Sendungen (z. B. des Polizeifunks, der öffentlichen beweglichen Landfunkdienste, Datenübertragungen) dürfen nicht aufgenommen werden, werden sie jedoch unbeabsichtigt empfangen, so dürfen sie weder aufgezeichnet, noch anderen mitgeteilt, noch für irgendwelche Zwecke ausgewertet werden. Das Vorhandensein solcher Sendungen darf auch nicht anderen zur Kenntnis gebracht werden.
4. Durch Ton- oder Fernseh-Rundfunkempfänger darf der Betrieb anderer elektrischer Anlagen nicht gestört werden.
5. Änderungen der Ton- oder Fernseh-Rundfunkempfänger, die die zulässigen Frequenzabstimmbereiche der Empfänger erweitern, gehen über den Umfang dieser Genehmigung hinaus und bedürfen vor ihrer Ausführung einer besonderen Genehmigung der Deutschen Bundespost. Wer aufgrund dieser Genehmigung einen Ton- oder Fernseh-Rundfunkempfänger betreibt, hat bei einer Änderung der kennzeichnenden Merkmale von Ton- oder Fernseh-Rundfunksendern (insbesondere bei Änderung des Sendeverfahrens oder bei Frequenzwechsel) die ggf. notwendig werdenden Änderungen an den Rundfunkempfängern auf seine Kosten vornehmen zu lassen.
6. Die Deutsche Bundespost ist berechtigt, Rundfunkempfänger und mit ihnen verbundene Geräte darauf zu prüfen, ob die Auflagen der Genehmigung und die Technischen Vorschriften eingehalten werden. Den Beauftragten der Deutschen Bundespost ist das Betreten der Grundstücke oder Räume, in denen sich Ton- oder Fernseh-Rundfunkempfänger befinden, zu den verkehrsüblichen Zeiten zu gestatten. Befinden sich die Rundfunkempfänger oder mit ihnen verbundene Geräte nicht im Verfügungsbereich desjenigen, der die Empfänger betreibt, so hat er den Beauftragten der Deutschen Bundespost Zutritt zu diesen Teilen zu ermöglichen.

Bei Funkstörungen die nicht durch Mängel der Rundfunkempfänger oder der mit ihnen verbundenen Geräte verursacht werden, können die Funkmedien der Deutschen Bundespost zur Feststellung der Störung in Anspruch genommen werden.

1. Diese Genehmigung kann allgemein oder durch die örtlich zuständige Oberpostdirektion einem einzelnen Betreiber gegenüber für einen bestimmten Rundfunkempfänger widerrufen werden. Ein Widerruf ist insbesondere Anlaß die Genehmigung zu widerrufen, wenn die unter Abschnitt II aufgeführten Auflagen nicht erfüllt werden. Gegen eine Auflage ein Ton- oder Fernseh-Rundfunkempfänger außer Betrieb zu setzen ist und erst bei Einhaltung der Auflagen wieder betrieben werden darf. Die Auflagen dieser Genehmigung können jederzeit ergänzt oder geändert werden.
2. Diese Genehmigung ersetzt die Allgemeine Ton- und Fernseh-Rundfunkgenehmigung vom 11.12.1970; sie gilt ab 1.7.1979.

Bonn, den 14.5.1979
Der Bundesminister für das Post- und Fernmeldewesen im Auftrag
Haist

PRECAUTIONS FOR INSTALLATION

Leave at least 10cm of space between this unit and any other component placed above.

SICHERHEITSMASSNAHMEN BEIM EINBAU

Lassen einen Mindestabstand von 10 cm zwischen diesem Gerät und der anderen Komponente, die daraufgestellt wird.

PRECAUTIONS D'INSTALLATION

Prévoir un espace d'au moins 10cm entre l'unité et tout autre appareil se trouvant au-dessus.

PRECAUZIONI PER L'INSTALLAZIONE

Lasciate uno spazio libero di almeno 10 cm fra quest'unità e qualsiasi altro componente che è collocato sopra la stessa.

PRECAUCIONES PARA LA INSTALACION

Deje por lo menos 10 cm. de espacio entre esta unidad y cualquier otro componente situado sobre ella.

VOORZORGSMAATREGELEN

Bij plaatsing dient u een ruimte van minstens 10 cm open te laten tussen dit toestel en een ander erop geplaatst component.

FÖRSIKTIGHETSÅTGÄRDER VID INSTALLATIONEN

Se till att det finns minst 10 cm mellanrum mellan apparaten och en ev. annan apparat som ställs ovanpå.

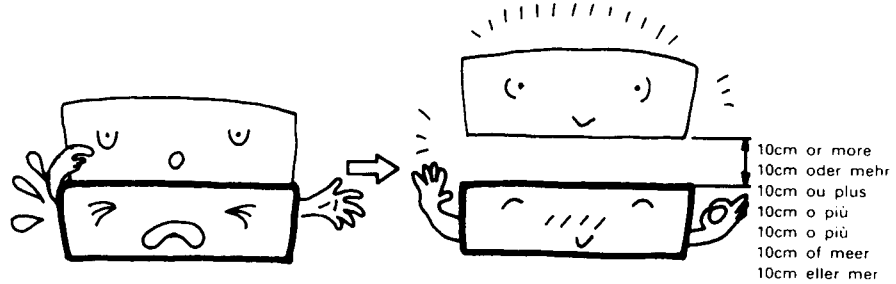

10cm or more
10cm oder mehr
10cm ou plus
10cm o più
10cm o più
10cm of meer
10cm eller mer

**NOTE ON USE/HINWEISE ZUM GEBRAUCH/OBSERVATIONS RELATIVES A L'UTILISATION
NOTE SULL'USO/NOTAS SOBRE EL USO/ALVORENS TE GEBRUIKEN/OBSERVERA**

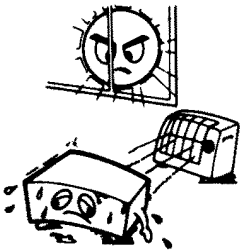

- Avoid high temperatures
Allow for sufficient heat dispersion when installed on a rack.
- Vermeiden Sie hohe Temperaturen
Sehen Sie zu, daß eine zureichende Luftzirkulation gewährleistet wird, wenn das Gerät auf ein Regal gestellt wird.
- Eviter des températures élevées
Tenir compte d'une dispersion de chaleur suffisante lors de l'installation sur une étagère.
- Evitate di esporre l'unità a temperature alte.
Assicuratevi che ci sia un'adeguata dispersione del calore quando installate l'unità in un mobile per componenti audio.
- Evite altas temperaturas
Permite la suficiente dispersión del calor cuando está instalado en la consola.
- Vermijd hoge temperaturen.
Zorg voor een degelijk hitteafvoer indien het apparaat op een rek wordt geplaatst.
- Undvik höga temperaturer.
Se till att det finns möjlighet till god värmeavledning vid montering i ett rack.

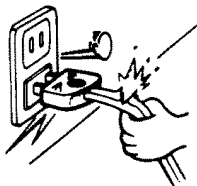

- Handle the power cord carefully.
Hold the plug when unplugging the cord.
- Gehen Sie vorsichtig mit dem Netzkabel um.
Halten Sie das Kabel am Stecker, wenn Sie den Stecker herausziehen.
- Manipuler le cordon d'alimentation avec précaution.
Tenir la prise lors du débranchement du cordon.
- Manneggiare il filo di alimentazione con cura.
Agitare per la spina quando scollegate il cavo dalla presa.
- Maneje el cordón de energía con cuidado.
Sostenga el enchufe cuando desconecte el cordón de energía.
- Hanteer het netsnoer voorzichtig.
Houd het snoer bij de stekker vast wanneer deze moet worden aan- of losgekoppeld.
- Hantera nätkabeln varsamt.
Håll i kabeln när den kopplas från eluttaget.

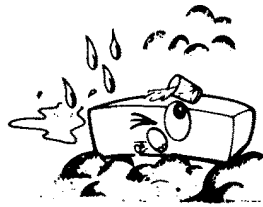

- Keep the set free from moisture, water, and dust.
- Halten Sie das Gerät fern von Feuchtigkeit, Wasser und Staub.
- Protéger l'appareil contre l'humidité, l'eau et la poussière.
- Tenete l'unità lontana dall'umidità, dall'acqua e dalla polvere.
- Mantenga el equipo libre de humedad, agua y polvo.
- Laat geen vochtigheid, water of stof in het apparaat binnendringen.
- Utsätt inte apparaten för fukt, vatten och damm.

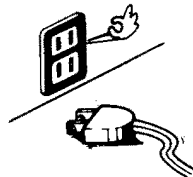

- Unplug the power cord when not using the set for long periods of time.
- Wenn das Gerät eine längere Zeit nicht verwendet werden soll, trennen Sie das Netzkabel vom Netzstecker.
- Débrancher le cordon d'alimentation lorsque l'appareil n'est pas utilisé pendant de longues périodes.
- Disinnestate il filo di alimentazione quando avete l'intenzione di non usare il filo di alimentazione per un lungo periodo di tempo.
- Desconecte el cordón de energía cuando no utilice el equipo por mucho tiempo.
- Neem altijd het netsnoer uit het stopkontakt wanneer het apparaat gedurende een lange periode niet wordt gebruikt.
- Koppla ur nätkabeln om apparaten inte kommer att användas i lång tid.

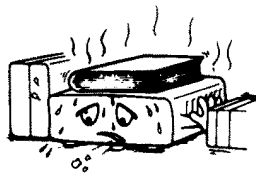

*(For sets with ventilation holes)

- Do not obstruct the ventilation holes.
- Die Belüftungsöffnungen dürfen nicht verdeckt werden.
- Ne pas obstruer les trous d'aération.
- Non coprite i fori di ventilazione.
- No obstruya los orificios de ventilación.
- De ventilatieopeningen mogen niet worden geblokkeerd.
- Täpp inte till ventilationsöppningarna.

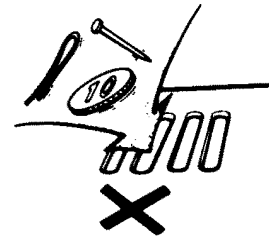

- Do not let foreign objects in the set.
- Keine fremden Gegenstände in das Gerät kommen lassen.
- Ne pas laisser des objets étrangers dans l'appareil.
- E' importante che nessun oggetto è inserito all'interno dell'unità.
- No deje objetos extraños dentro del equipo.
- Laat geen vreemde voorwerpen in dit apparaat vallen.
- Se till att främmande föremål inte tränger in i apparaten.

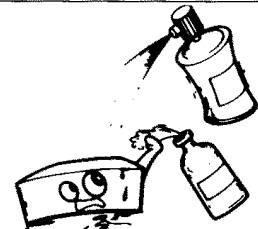

- Do not let insecticides, benzene, and thinner come in contact with the set.
- Lassen Sie das Gerät nicht mit Insektiziden, Benzin oder Verdünnungsmitteln in Berührung kommen.
- Ne pas mettre en contact des insecticides, du benzène et un diluant avec l'appareil.
- Assicuratevi che l'unità non venga in contatto con insetticidi, benzolo o solventi.
- No permita el contacto de insecticidas, gasolina y diluyentes con el equipo.
- Laat geen insectenverdelgende middelen, benzine of ververdunner met dit apparaat in contact komen.
- Se till att inte insektsmedel på spraybruk, bensen och thinner kommer i kontakt med apparatens hölje.

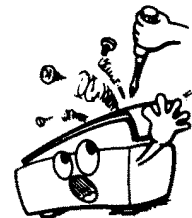

- Never disassemble or modify the set in any way.
- Versuchen Sie niemals das Gerät auseinander zu nehmen oder auf jegliche Art zu verändern.
- Ne jamais démonter ou modifier l'appareil d'une manière ou d'une autre.
- Non smontate mai, nè modificate l'unità in nessun modo.
- Nunca desarme o modifique el equipo de ninguna manera.
- Nooit dit apparaat demonteren of op andere wijze modificieren.
- Ta inte isär apparaten och försök inte bygga om den.

**FRONT PANEL
FRONTPLATTE
PANNEAU AVANT**

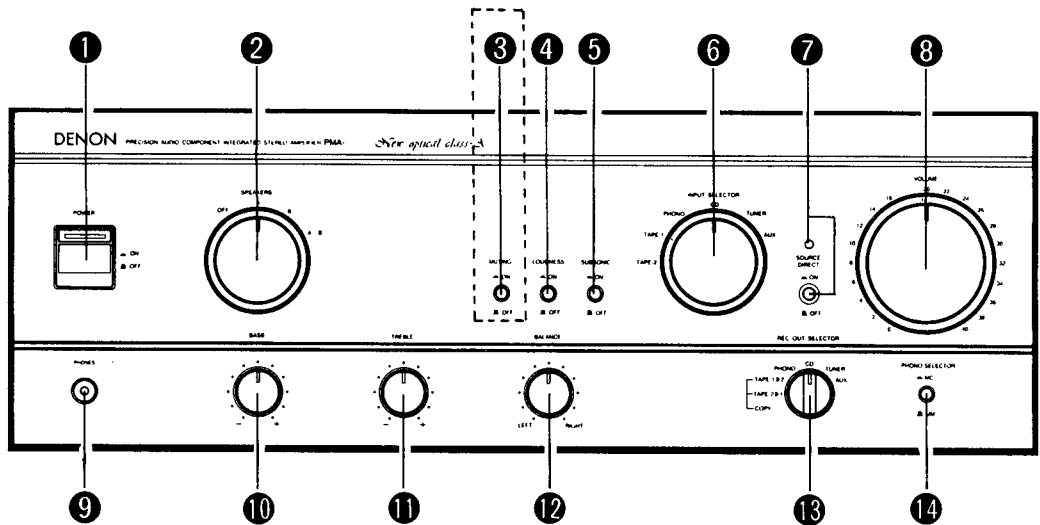

**BACK PANEL
RÜCKWAND
PANNEAU ARRIERE**

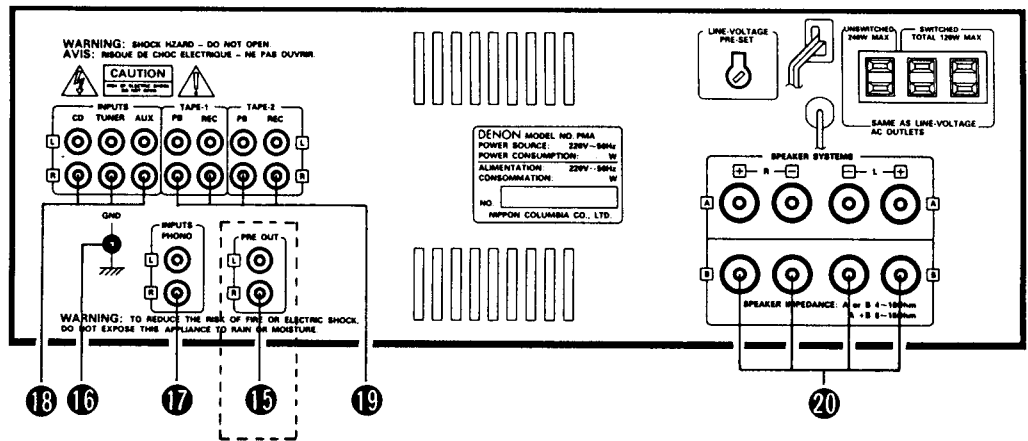
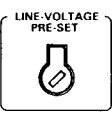

Fig. 1
Abb. 1

15 PREOUT *PMA-1060 only	16 GND	17 PHONO	18 CD, TUNER, AUX	19 TAPE-1, TAPE-2 • TAPE PB • TAPE REC	20 SPEAKERS
PRE OUT Terminals	GND	Phono Input Terminals	Input Terminals	Playback and Recording Terminals • Playback Terminals • Recording Terminals	Speaker Terminal
Vorverstärker-klemmen (PRE OUT)	GND	Schallplattenspieler-Eingangsbuchsen	Eingangsbuchsen CD, TUNER, AUX	Tonband-Ein/Ausgänge • Wiedergabe • Aufnahme	Lautsprecherklemmen
Bornes de sortie préamplifiée (PRE OUT)	GND	Bornes d'entrée phono	Bornes d'entrée	Bornes de lecture et d'enregistrement • Bornes de lecture • Bornes d'enregistrement	Bornes de haut-Parleurs

• **AC OUTLETS . . . For U.S.A., Canada and Multi-voltage models.** AC outlets are used for connecting amplifier component units, such as tuner, turntable, tape deck, etc.

- **SWITCHED** (Total capacity: 120 W): These outlets are turned ON/OFF when main power switch is turned on/off.
- **UNSWITCHED** (Capacity: 240 W) This outlet is always ON whether power switch is on or OFF.
- **LINE VOLTAGE (Voltage select switch) . . . For Multi-voltage model only.**
 - * The desired voltage may be set with the **VOLTAGE SELECTOR KNOB** on the back panel using a screw driver.
 - * Do not twist the **VOLTAGE SELECTOR KNOB** with excessive force. It may be damaged.
 - * If the voltage select switch does not turn smoothly, see qualified serviceman.



• **Sorties CA . . . Pour les E.U., le Canada et les modèles multi-tension.** Les AC OUTLETS (sorties CA) peuvent être utilisées pour enficher des cordons d'alimentation d'appareils connectés à l'ampli, tels que tuner, lecteur de disque ou magnétophone.

- **SWITCHED** (en circuit) (Capacité max: 120 W) Cette alimentation sont commandées par l'interrupteur d'alimentation principal (POWER), et ouvertes (ON) et coupées (OFF) par cet interrupteur.
- **UNSWITCHED** (hors circuit) (Capacité max.: 240 W) Ces alimentations n'est pas connectée à l'interrupteur (POWER).

**CONNECTIONS
ANSCHLÜSSE
CONNEXIONS**

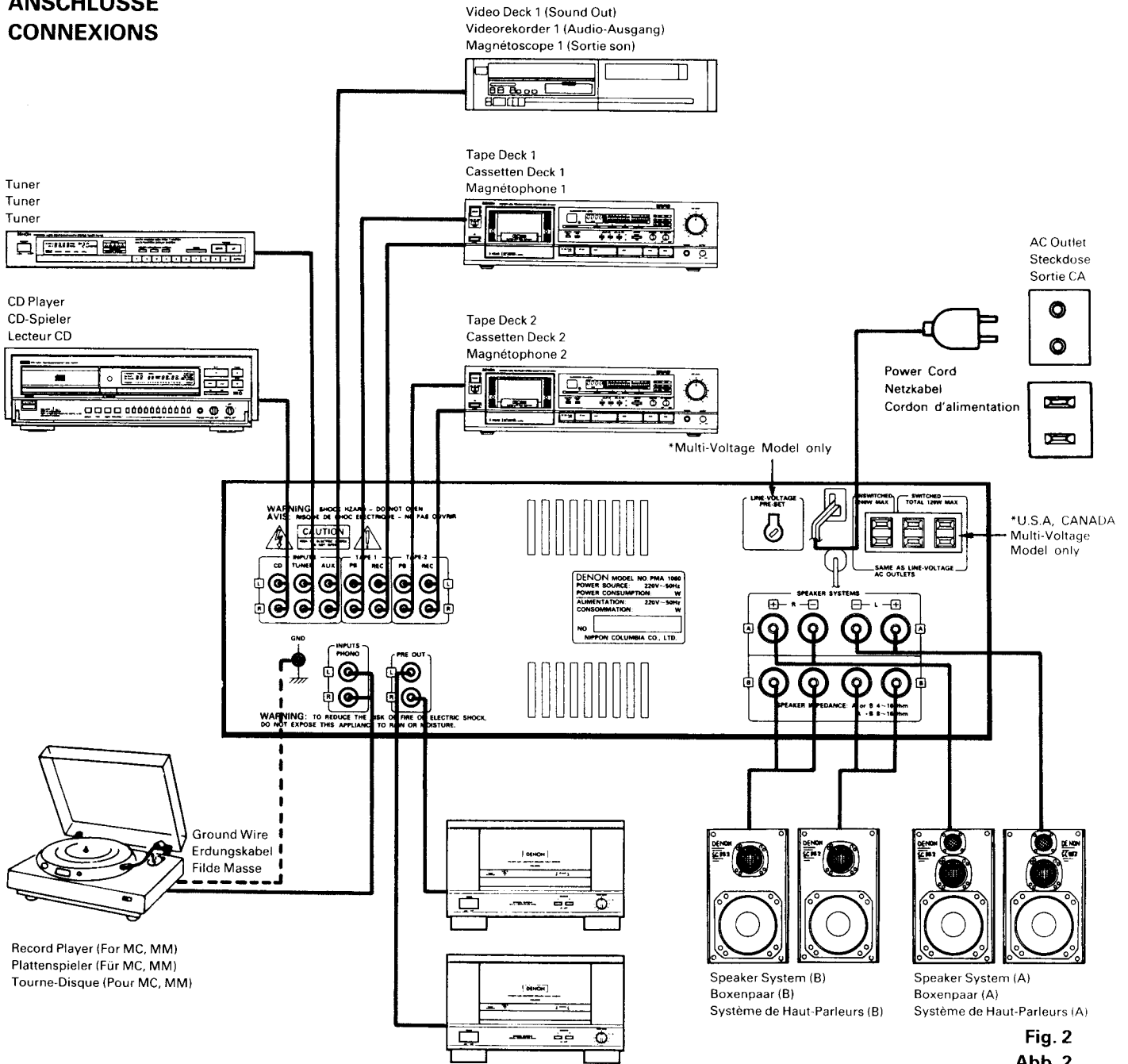



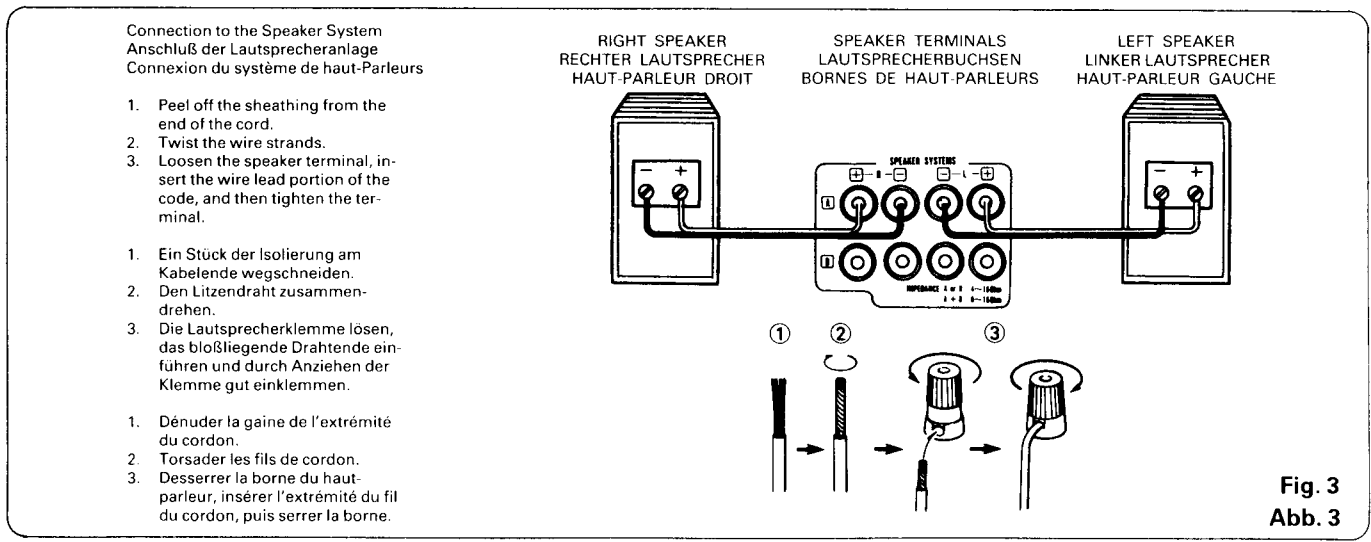











**Fig. 2
Abb. 2**



**Fig. 3
Abb. 3**

DESIGNATIONS AND FUNCTIONS OF PANEL CONTROLS

- 1 POWER (Power Switch)**
When the power switch is turned ON (), the power indicator lights.
When the power switch is turned ON, power is supplied to the unit. It takes a few seconds after the power is turned on for the unit to warm up. This is due to the built-in muting circuit that eliminates noise during the on/off operation.
- 2 SPEAKERS (Speaker Selector Switch)**
- OFF: This setting cuts the sound from the speakers and is used for headphones listening.
 - A: The speaker system connected to the "A" speaker output terminals operates.
 - B: The speaker system connected to the "B" speaker output terminals operates.
 - A + B: The two pairs of speakers connected to the "A" and "B" speaker output terminals operate simultaneously.
- 3 MUTING (Muting Switch) *PMA-1060 only**
To lower the volume level to -20 dB of its current level, set the MUTING button to ON ().
- 4 LOUDNESS (Loudness Switch)**
When the volume is low, it is difficult for the human ear to clearly distinguish notes in the low and high frequency ranges. The loudness switch allows a simple "one-touch" correction of this difficulty. Press the loudness switch ON () when listening to music at a low volume. The low notes and high notes will be corrected to produce a natural sound.
- 5 SUBSONIC (Subsonic Filter Switch)**
Use to prevent subsonic speaker vibration due to vibration of the player motor or a warped record, etc., when playing a connected player.
- 6 INPUT SELECTOR (Input Select Switch)**
This switch is used to select the input signal for the program source.
- PHONO: Used to select the output from a turntable that is connected to the PHONO terminal. Use the PHONO switch **14** to switch the sensitivity to correspond to the cartridge type being used.
 - CD: Used to play a compact disc player or other component that is connected to the CD terminal.
 - TUNER: Used to play a component such as an FM/AM tuner or a TV tuner that is connected to the TUNER terminal.
 - AUX: Used to play a component such as a Hi Fi video player, TV tuner or tape deck that is connected to the AUX terminal.
 - TAPE-1: Used to play a tape deck or other component that is connected to the TAPE-1 or TAPE-2 terminal.
 - TAPE-2
- 7 SOURCE DIRECT (Source Direct Switch)**
Set this switch to ON () will cause the input signal to by-pass the MUTING **3** (PMA-1060 only), LOUDNESS **4**, SUBSONIC **5**, BASS **10**, TREBLE **11**, BALANCE **12** circuits (regardless of the settings of these controls) and be input directly to the VOLUME **8** control to prevent loss of sound quality. The SOURCE DIRECT indicator will light up at this time.
- 8 VOLUME (Volume Control)**
This knob controls the overall volume level. Turn the knob to the right () to raise the volume and to the left () to lower it.
- 9 PHONES (Headphone Jack)**
This jack is used to plug in the headphones.
- 10 BASS (Bass Control)**
This knob is used to control the bass quality of the sound. When the knob is set at the center position, the frequency characteristics are flattened in the range below 1000 Hz. The bass is emphasized as the knob is moved off center to the right (), and reduced as it is moved to the left (). When volume control **8** is set to the right of the center position, the effect of the other controls is reduced.
- 11 TREBLE (Treble Control)**
This knob is used to control the treble quality of the sound. When the knob is set at the center position, the frequency characteristics are flattened in the range above 1000 Hz. The treble is emphasized as the knob is moved off center to the right (), and reduced as it is moved to the left (). When volume control **8** is set to the right of the center position, the effect of the other controls is reduced.
- 12 BALANCE (Balance Control)**
This knob is used to adjust the balance between the left and right channels. When it is set to the center position, the amplitude of the amplifier is equal on both sides. If there is a difference in the left and right channel output voltages for a cartridge, move the knob to the left and the right to adjust it. If the volume on the right side is too low, turn the knob to the right (). If the volume on the left side is too low, turn the knob to the left (). This will achieve an even balance on the left and right sides.
- 13 REC OUT SELECTOR (Rec Out Select Switch)**
Use this switch to select the recording component.
- PHONO: Used to recording from the turntable.
 - CD: Used to recording from the CD player.
 - TUNER: Used to recording from the tuner.
 - AUX: Used to recording component that connected to the AUX terminal.
 - TAPE-1 ▶ 2: Used to recording from the tape deck connected to the TAPE-1 jacks.
 - TAPE-2 ▶ 1: Used to recording from the tape deck connected to the TAPE-2 jacks.
- 14 PHONO (Cartridge Selection Switch)**
This switch is set according to the type of player cartridge to be used.
- MC (): Used when an MC (moving-coil) cartridge with an output of less than 0.5 mV is used.
 - MM (): Used when an MM (moving-magnet) cartridge with an output of 2 mV or more is used.
- 15 PRE OUT (Back Panel side) *PMA-1060 only**
Output signals for POWER amplifiers are sent from these jacks. The rated output is 1.0 volt.

OPERATION

PREPARATION

1. CHECKING CONNECTIONS

- Make sure that all the connections are proper by referring to the back panel. (Fig. 2, 3)
- Check the polarity (positive and negative) of connections, and the directivity of stereo separation (right cord to right channel terminal, and left cord to left channel terminal).
- Check the directivity of pin cord connection.

2. SETTING OF EACH KNOB

- Turn the volume control knob counterclockwise, to "0".
- Set the rotary knob to "flat".
- Set SOURCE DIRECT, LOUDNESS, SUBSONIC, and MUTING (PMA-1060 only) to "OFF (■)".

After checking the above items, turn on the power, the amplifier is set in the ready mode in a few seconds after the power LED is lit.

PLAYING A RECORD

1. Set the INPUT SELECTOR switch to "PHONO".
2. Operate the turntable and play the record.
3. Turn the volume and tone controls to yield an appropriate volume and sound quality.

PLAYBACK OF CD PLAYER

1. Set the INPUT SELECTOR switch to "CD".
2. Operate the CD player.
3. Turn the volume and tone controls to yield an appropriate volume and sound quality.

RECEPTION OF RADIO PROGRAMS

1. Set the INPUT SELECTOR switch to "TUNER".
2. Operate the tuner to receive a radio program.
3. Turn the volume and tone controls to yield an appropriate volume and sound quality.

CONNECTIONS OF AUDIO EQUIPMENT TO AUX TERMINALS

1. Set the INPUT SELECTOR switch to "AUX" Position.
2. Operate the Audio equipment Systems.
3. Turn the volume and tone controls to yield an appropriate volume and sound quality.

PLAYBACK WITH TAPE DECK

1. Set the INPUT SELECTOR switch to "TAPE-1" or "TAPE-2".
2. Operate the Tape Deck.
3. Turn the volume and tone controls to yield an appropriate volume and sound quality.

RECORDING WITH TAPE DECK

1. Set the REC OUT SELECTOR to the program source you wish to record.
 2. Start the playback of the program source.
 3. Start recording with the component connected to "TAPE-1" or "TAPE-2".
- In the PMA-1060/860, the REC OUT signal and the speaker (headphone) signal are output via separate circuits so that knobs and switches related to the tone and volume have no effect whatsoever on the sound that is recorded. Also, since the recording function is selected by the REC OUT SELECTOR, the free program source can be played through the speakers (or headphones) even during recording.

• MONITORING THE RECORDING

A recording in progress can be monitored if a tape deck with three individual heads for recording and playback is used. A tape deck in which a common head is used for both recording and playback cannot be used to monitor recording. When a recording is being made using TAPE-1, selecting TAPE-1 with the INPUT SELECTOR will engage the RECORDING MONITOR and permit a check of the recording condition.

CAUTION

Protective Circuit

This set is equipped with a high speed protective circuit. This circuit protects the internal circuitry from damage due to large currents flowing when the speaker jacks are not completely connected or when an output is generated by a short circuit. This protective circuit's operation cuts off the output to the speakers. In such a case, be sure to turn the power to the set off and check the connections to the speakers. Then turn the power on again. After muting for several seconds, the set will operate normally.

Technical Data (typical value)	Technische Daten (typische werte)	PMA-1060	PMA-860
<p>• POWER AMPLIFIER SECTION Rated Output Power: *¹Both channel drive (8 ohm Load) 20 Hz to 20 kHz, (4 ohm Load) DIN, 1 kHz, T.H.D. 0.7%</p> <p>*²Continuous ()W per channel min into 8 ohms from 20 Hz to 20 kHz with no more than ()% total harmonic distortion</p> <p>Total Harmonic Distortion: (-3 dB at rated output, 8 ohms)</p> <p>• PRE AMPLIFIER SECTION Rated Output: (Recout Terminal)</p> <p>Input Sensitivity/ Input Impedance: The value in parentheses () refers to the input impedance when SOURCE DIRECT is ON.</p> <p>PHONO: CD, TUNER AUX TAPE-1, TAPE-2:</p> <p>RIAA Deviation: PHONO: Within ±0.3 dB Maximum Input:</p>	<p>• LEISTUNGSENDSTUFE Nenn-Ausgangsleistung: *¹Beide Kanäle betriebeem (an 8 Ohm) 20 Hz bis 20 kHz (an 4 Ohm) DIN, 1 kHz, T.H.D. 0,7%</p> <p>*²Fortlaufend ()W pro Kanal zu 8 Ohm von 20 Hz bis 20 kHz mit einem Gesamtklirrfaktor von nicht mehr als ()%.</p> <p>Gesamtklirrfaktor: (-3 dB bei Nennausgang, 8 Ohm)</p> <p>• VORVERSTÄRKER Nenn-Ausgangsleistung: (Aufnahme-Ausgangsbuchse)</p> <p>Eingangsempfindlichkeit/ Eingangsimpedanz: Der in Klammern () angegebene Wert bezieht sich auf die Eingangs- impedanz, wenn der Quellen- Direktschalter (SOURCE DIRECT) eingeschaltet (ON) ist.</p> <p>PHONO: CD, TUNER, AUX TAPE-1, TAPE-2:</p> <p>Abweichung von der RIAA-Kennlinie: PHONO: Innerhalb ±0,3 dB Maximaler Eingang:</p>	<p>105W + 105W T.H.D. 0.005%</p> <p>180W + 180W</p> <p>105W/0.005%</p> <p>0.004%</p> <p>150 mV</p> <p>MM 2.5 mV / 47 kohm MC 200 µ V / 100 ohm 150 mV / 47 kohm (150 mV / 10 kohm)</p> <p>20 Hz~20 kHz PHONO MM 160 mV / 1 kHz MC 12 mV / 1 kHz</p> <p>PHONO: MM: 94 dB (at 5 mV input) MC: 75 dB (at 0.5 mV input) CD, TUNER, AUX TAPE-1, TAPE-2: 110 dB</p> <p>100 Hz ± 8 dB 10 kHz ± 8 dB 100 Hz + 7 dB 10 kHz + 6 dB 16 Hz, 12 dB / oct.</p> <p>AC220V/50 Hz, 240V/50 Hz AC 120 V/60 Hz AC 110/120/220/240 V, 50/60 Hz</p> <p>120W (Total) 240W</p> <p>280W (IEC) 5.7A (U.S.A. and Canada) 244W (Multi-Voltage) 434(W)×160(H)×398(D)mm (17-3/32"×6-19/64"× 16-43/64") 12.4 kg (27 lbs 6 oz)</p>	<p>80W + 80W T.H.D. 0.01%</p> <p>135W + 135W</p> <p>80W/0.01%</p> <p>0.007%</p> <p>150 mV</p> <p>MM 2.5 mV / 47 kohm MC 200 µ V / 100 ohm 150 mV / 47 kohm (150 mV / 10 kohm)</p> <p>20 Hz~20 kHz PHONO MM 160 mV / 1 kHz MC 12 mV / 1 kHz</p> <p>PHONO: MM: 94 dB (at 5 mV input) MC: 75 dB (at 0.5 mV input) CD, TUNER, AUX TAPE-1, TAPE-2: 110 dB</p> <p>100 Hz ± 8 dB 10 kHz ± 8 dB 100 Hz + 7 dB 10 kHz + 6 dB 16 Hz, 12 dB / oct.</p> <p>AC220V/50 Hz, 240V/50 Hz AC 120 V/60 Hz AC 110/120/220/240 V, 50/60 Hz</p> <p>120W (Total) 240W</p> <p>250W (IEC) 4.5A (U.S.A. and Canada) 192W (Multi-Voltage) 434(W)×160(H)×397(D)mm (17-3/32"×6-19/64"× 15-5/8") 9.7 kg (21 lbs 7 oz)</p>
<p>• OVERALL CHARACTERISTICS SN Ratio (IHF A Network):</p> <p>(input terminals short- circuited) SOURCE-DIRECT: ON</p> <p>Tone Control Adjustable Range: BASS TREBLE Loudness:</p> <p>Subsonic Filter:</p> <p>• OTHERS Power Supply</p> <p>AC Outlets *²Switched×2: Unswitched×1:</p> <p>Power Consumption</p> <p>Dimensions (W)×(H)×(D)</p> <p>Net Weight</p>	<p>• GESAMTEIGENSCHAFTEN GENERALES Signal/Rauschabstand (IHF-A-Weiche):</p> <p>(Eingänge kurzgeschlossen) SOURCE DIRECT: ON</p> <p>Klangregelbereich:</p> <p>TIEFEN (BASS) HÖHEN (TREBLE) Gehörliche Lautstärke:</p> <p>Unterschall-Schaltung:</p> <p>• SONSTIGES Netzspannung und- frequenz</p> <p>Wechselstrom-Ausgänge *²Geschaltet×2: Ungeschaltet×1:</p> <p>Leistungsaufnahme</p> <p>Abmessungen (B)×(H)×(T)</p> <p>Nettogewicht</p>	<p>PHONO: MM: 94 dB (at 5 mV input) MC: 75 dB (at 0.5 mV input) CD, TUNER, AUX TAPE-1, TAPE-2: 110 dB</p> <p>PHONO: MM: 94 dB (at 5 mV input) MC: 75 dB (at 0.5 mV input) CD, TUNER, AUX TAPE-1, TAPE-2: 110 dB</p>	<p>PHONO: MM: 94 dB (at 5 mV input) MC: 75 dB (at 0.5 mV input) CD, TUNER, AUX TAPE-1, TAPE-2: 110 dB</p>

- Specifications and contents are subject to change without notice for purposes of improvement.
- Änderungen des Inhalts und der technischen Daten zum Zwecke der Verbesserung vorbehalten.

*¹ For Europe
 *² For U.S.A. Canada and
 Multi-Voltage

*¹ Für Europa
 *² Für U.S.A., Kanada und
 Mehrfach-Spannung

BLOCK, LEVEL DIAGRAM

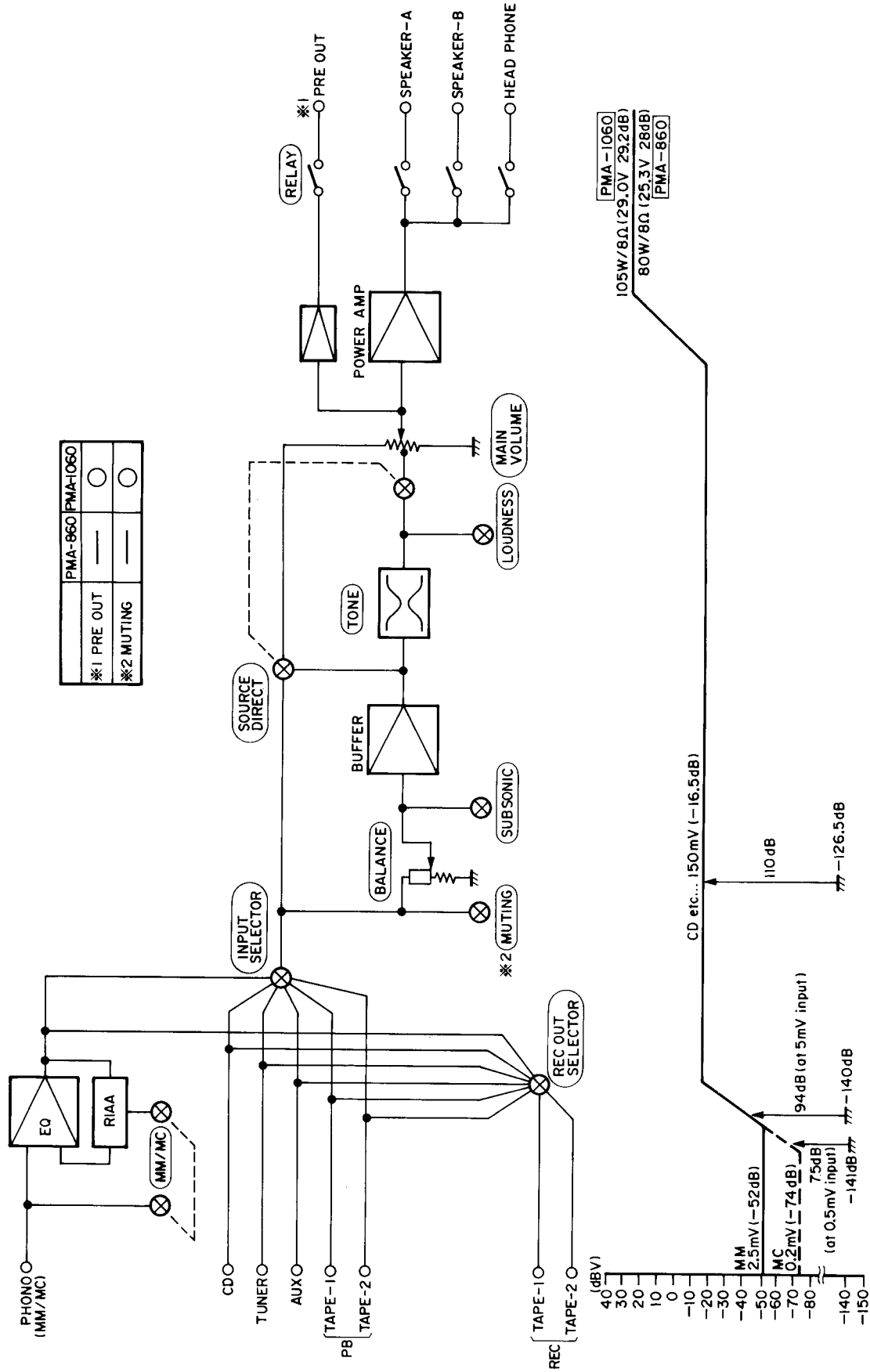

METHOD OF ADJUSTMENTS

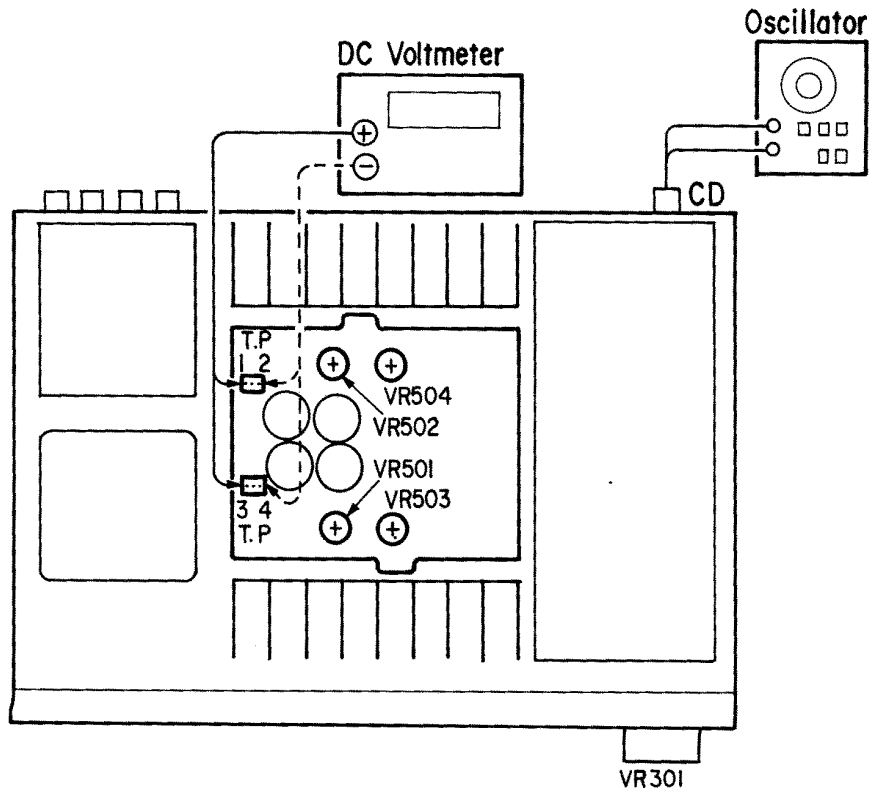

IDLING CURRENT

● Setup

1. Lay the unit at an ordinary position away from a direct current from a cooler or fan. Do the adjustment at a temperature between 15°C (59°F) and 30°C (86°F).
2. Set control as follows.

POWER switch	→	OFF (■)
VOLUME control	→	fully counterclockwise (↺ min.) (main volume [VR301] and semifixed resistors [VR501, 502, 503 and 504])
SPEAKER terminals	→	open: do not connect the speakers, dummy load etc.

● Adjustment

1. Remove top cover. And then connect DC voltmeter to test points of P.AMP & SUPPLY UNIT (1U-2029 for PMA-860, 1U-2031 for PMA-1060).
2. Connect power cord to AC outlet, and turn POWER switch "ON" (■). Within 10 seconds turn VR501 (L ch) and VR502 (R ch) clockwise so that the DC Voltmeter reads $8 \pm 0.5\text{mV}$ (PMA-1060), $5 \pm 0.5 \text{ mV}$ (PMA-860).
3. Then after 2 minutes warmup adjust VR501 and VR502 so that the DC voltmeter reads $8 \pm 0.5\text{mV}$ (PMA-1060), $5 \pm 0.5 \text{ mV}$ (PMA-860).
4. And after 10 minutes warmup adjust VR501 and VR502 so that the DC voltmeter reads $8 \pm 0.5\text{mV}$ (PMA-1060), $5 \pm 0.5 \text{ mV}$ (PMA-860).
5. Apply a 1 kHz, 10 mVrms signal to both channels input and set the main volume at maximum position.
6. Confirm that the indication of DC voltmeter becomes slightly greater value (approx. 10 mV or less), then adjust the VR503 (L ch), VR504 (R ch) clockwise to obtain $30 \text{ mV} \pm 3 \text{ mV}$ on the meter.
7. After 2 minutes, readjust the VR503, VR504 for $30 \pm 3 \text{ mV}$.
8. And after 10 minutes warmup, adjust VR503, VR504 for $30 \text{ mV} \pm 3 \text{ mV}$.

REMOVAL OF EACH SECTION

1. Top Cover

Remove 8 screws, then detach Top Cover as the arrow shows with opening the Cover a little laterally.

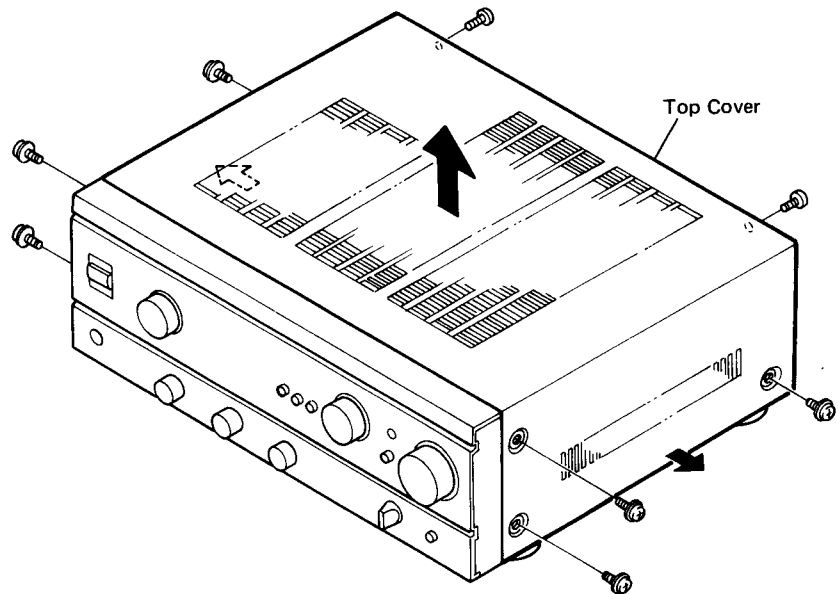

2. Front Panel

Remove 7 fixing screws and 3 knobs of the Front Panel, and detach the Front Panel as arrow shows. Then, remove 2 screws each on both sides, and detach both Side Plates.

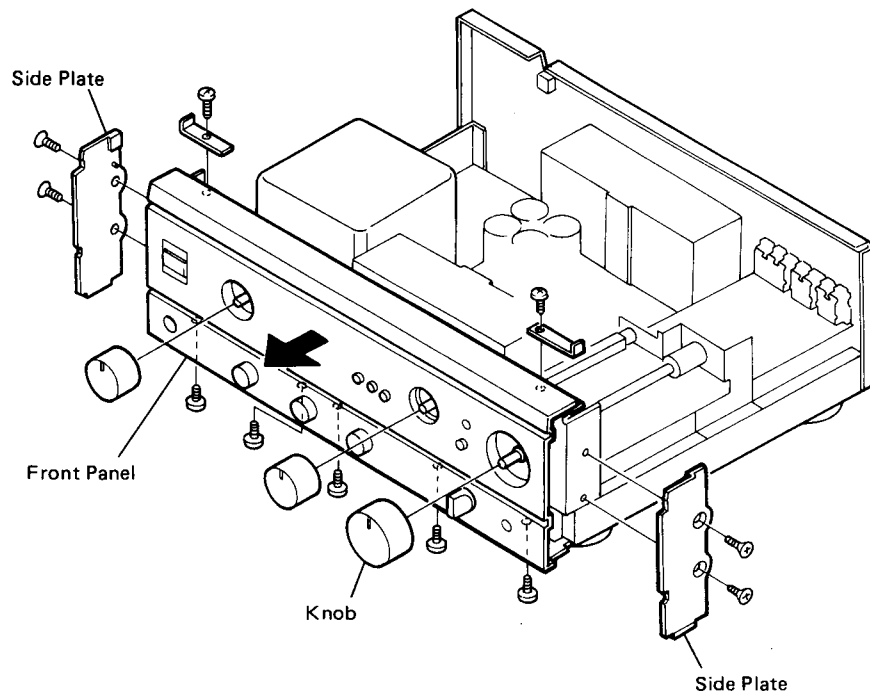

PRINTED WIRING BOARD

1U-2031 P. AMP & SUPPLY UNIT (FOR PMA-1060)

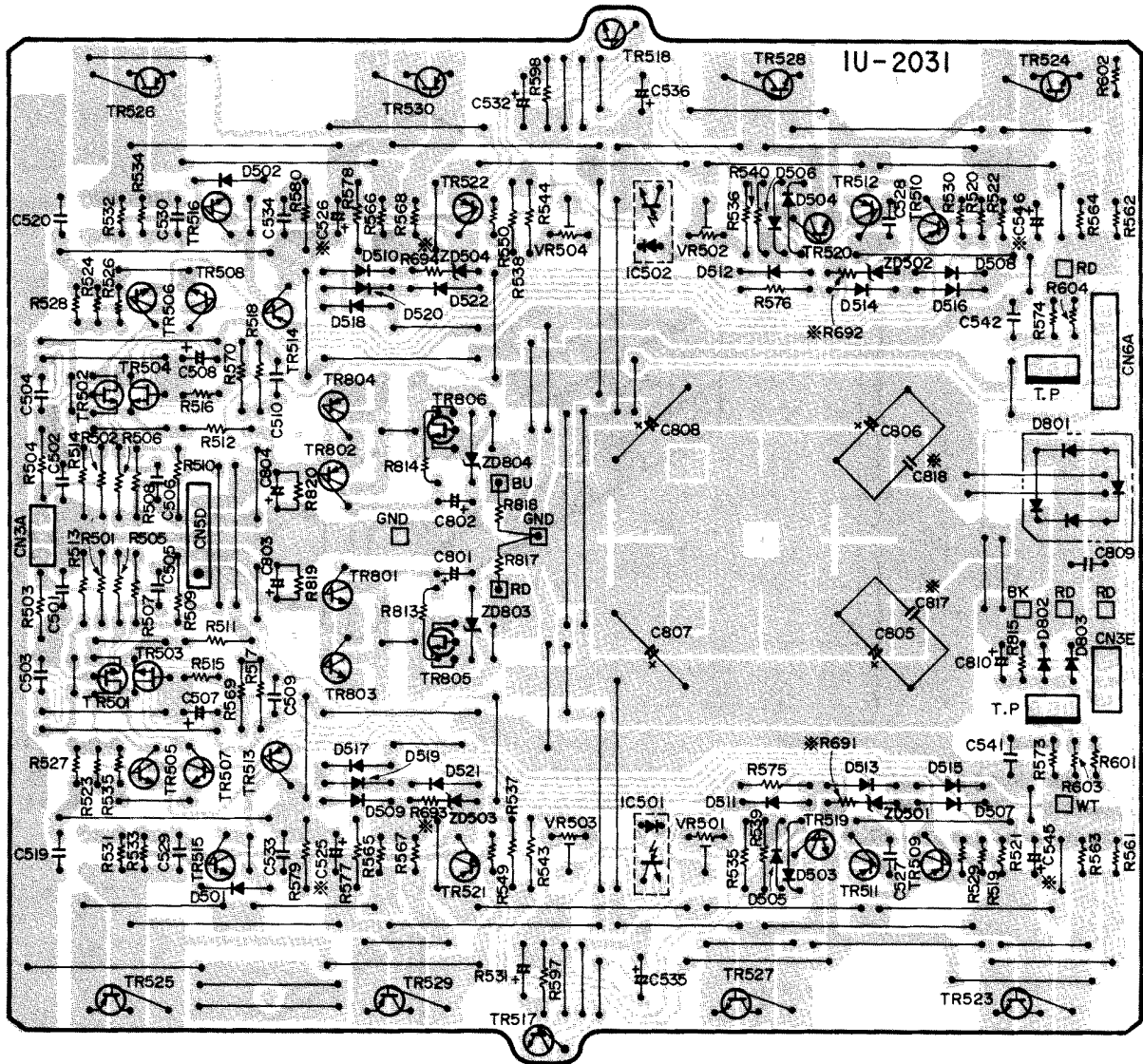

1U-2092 POWER SWITCH UNIT (FOR PMA-1060)

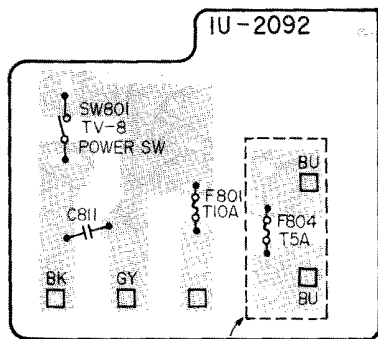

Multi-Voltage Model Only

1U-2030 INPUT & CONTROL UNIT (FOR PMA-1060)

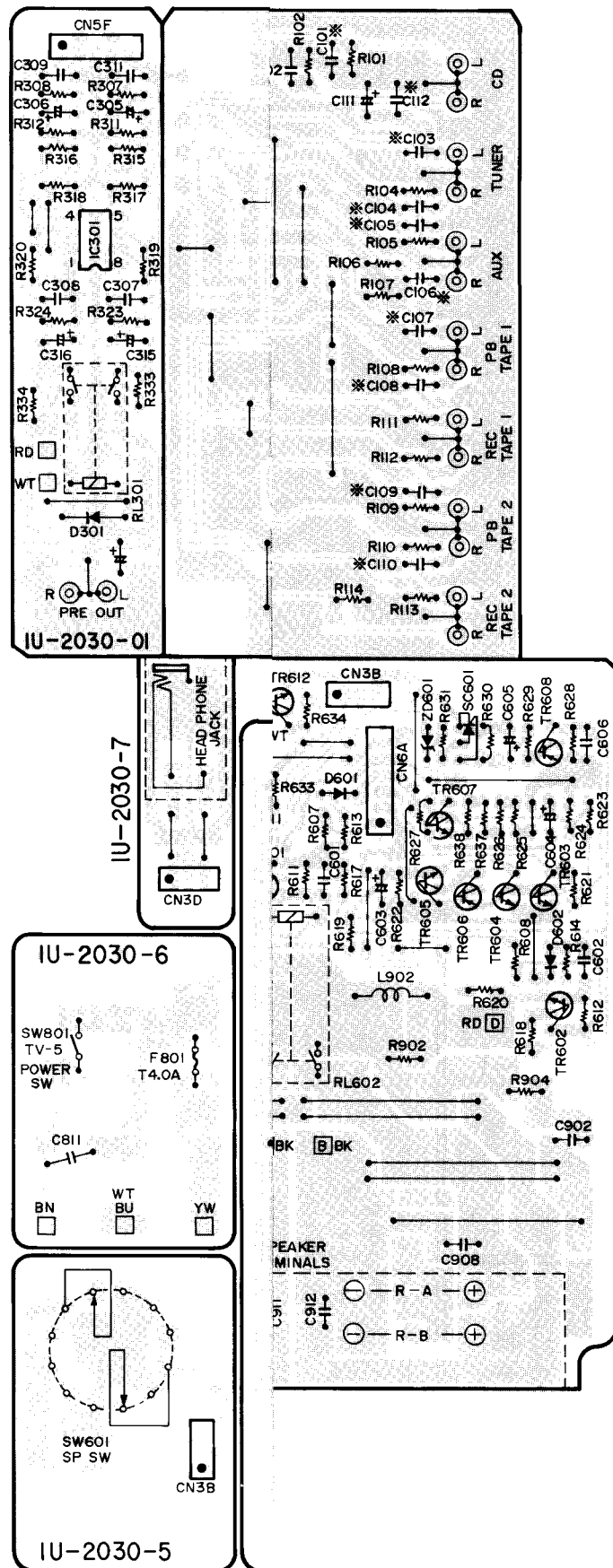

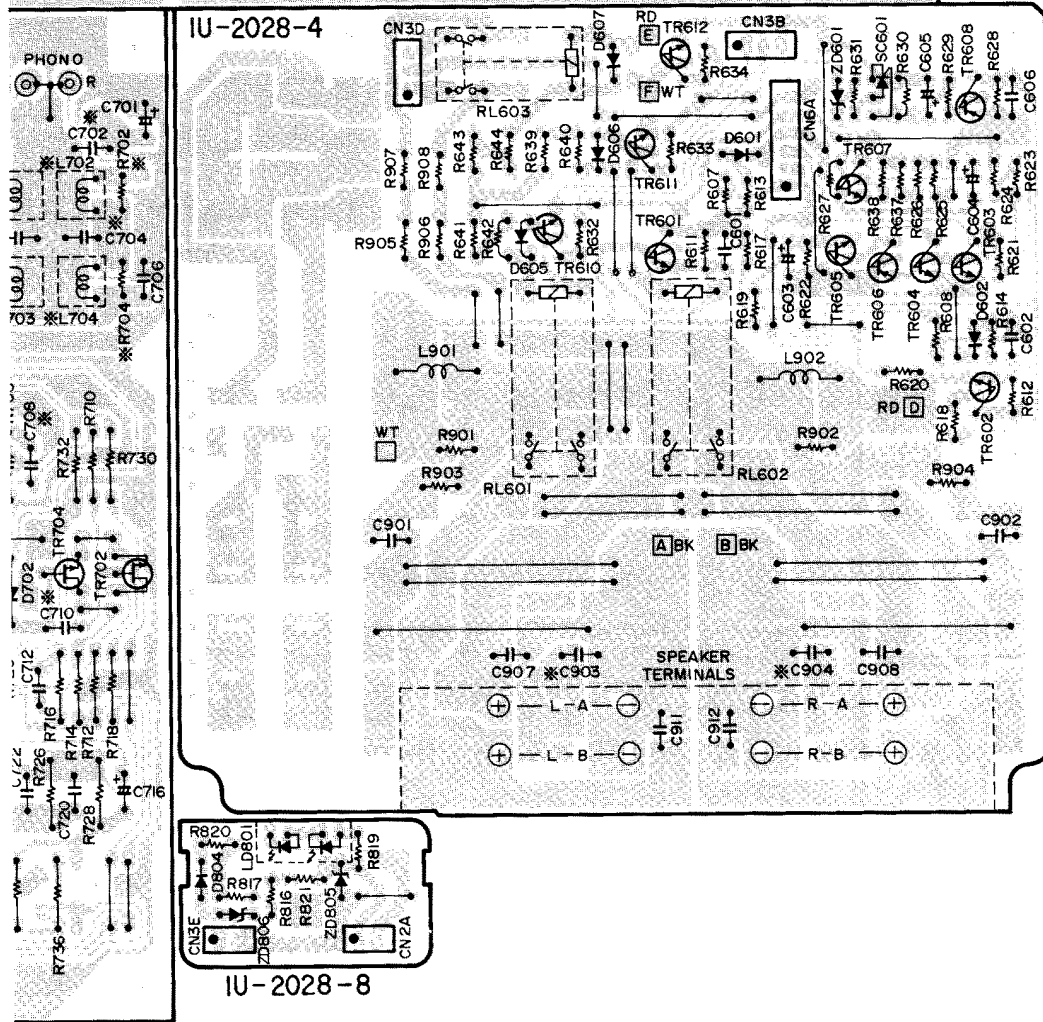
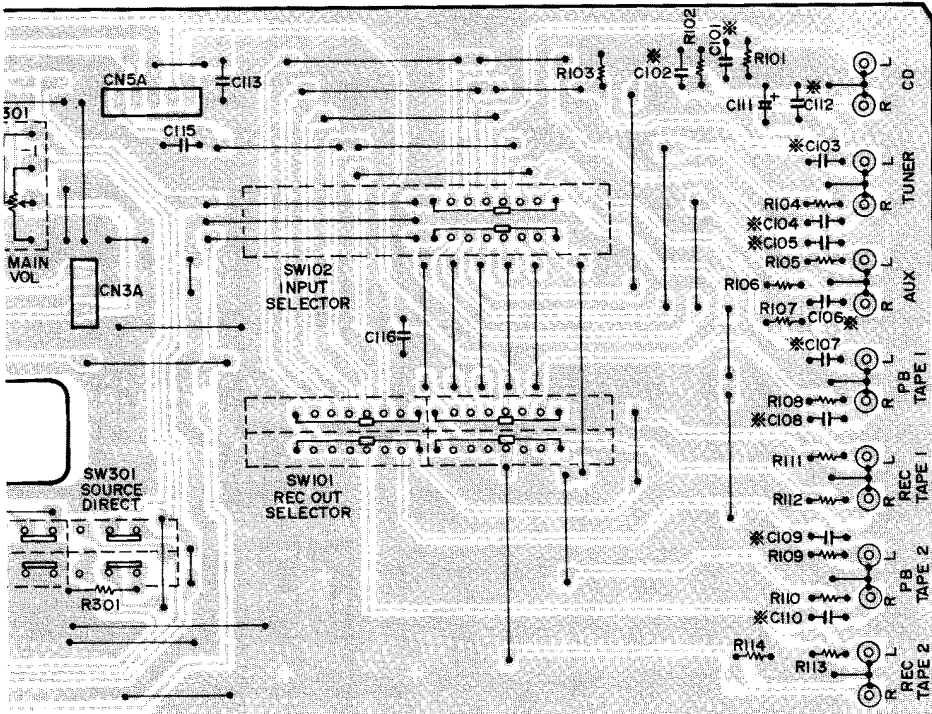

IU-2028-4

IU-2028-8

1U-2029 P. AMP & SUPPLY UNIT (FOR PMA-860)

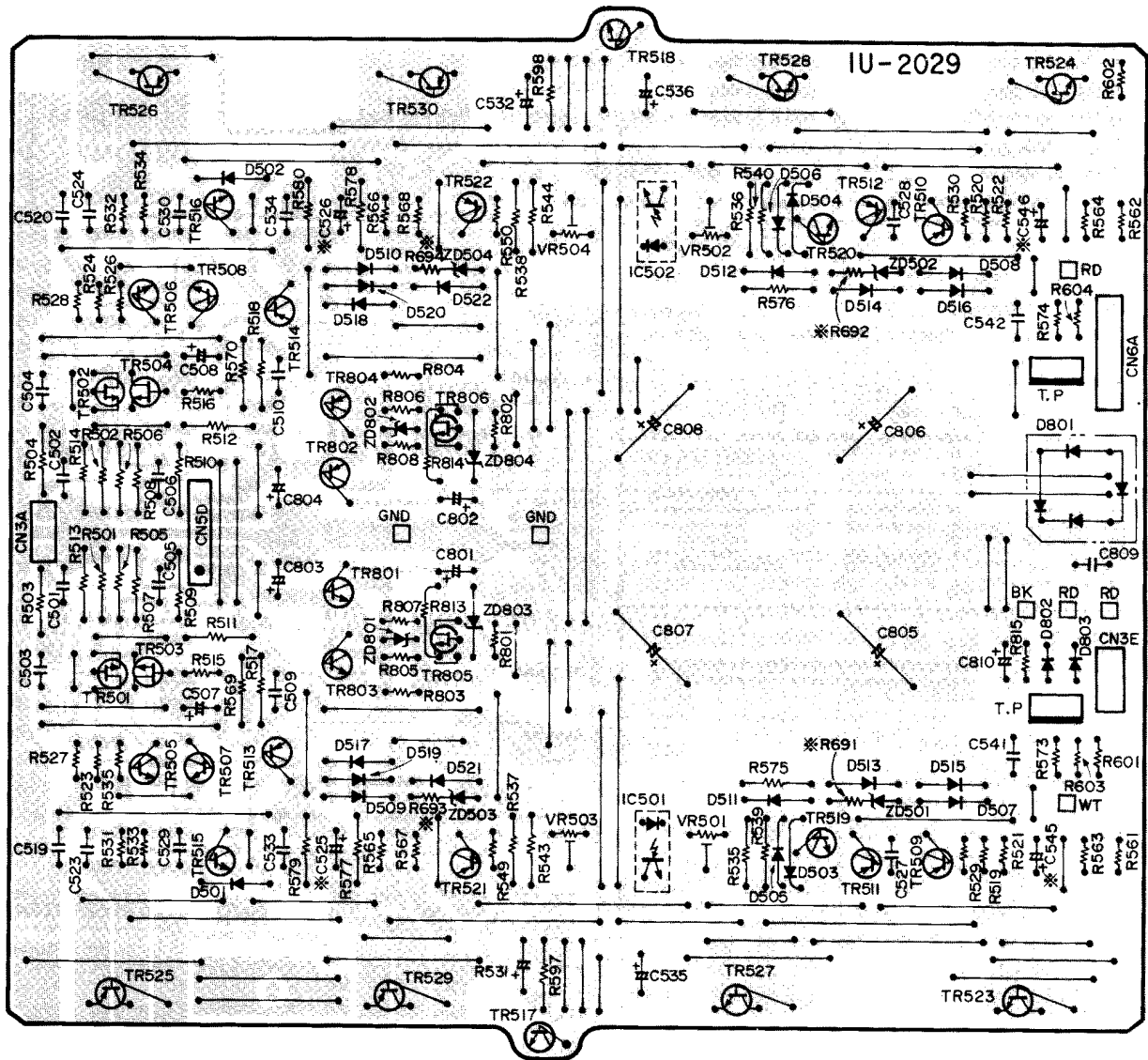

1U-2091 POWER SWITCH UNIT (FOR PMA-860)

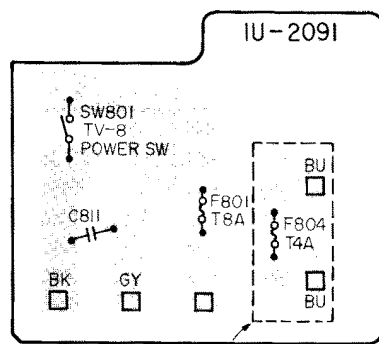

Multi-Voltage Model Only

NOTE FOR PARTS LIST

- Part indicated with the mark "◎" are not always in stock and possibly to take a long period of time for supplying, or in some case supplying of part may be refused.
- When ordering of part, clearly indicate "1" and "I" (i) to avoid mis-supplying.
- Ordering part without stating its part number can not be supplied.
- Part indicated with the mark "★" is not illustrated in the exploded view.
- Not including Carbon Film ±5%, 1/4W Type in the P.W.Board parts list. (Refer to the Schematic Diagram for those parts.)

WARNING:

Parts marked with this symbol  have critical characteristics.
Use ONLY replacement parts recommended by the manufacturer.

● **Resistors**

Ex.: **RN** **14K** **2E** **182** **G** **FR**
 Type Shape and performance Power Resistance Allowable error Others

RD : Carbon	2B : 1/8W	F : ±1%	P : Pulse-resistant type
RC : Fixed	2E : 1/4W	G : ±2%	NL : Low noise type
RS : Metallic film	2H : 1/2W	J : ±5%	NB : Non-burning type
RW : Winding	3A : 1W	K : ±10%	FR : Fuse resistor
RN : Metal film	3D : 2W	M : ±20%	F : Lead wire forming
RK : Metal mixture	3F : 3W		
	3H : 5W		

Resistance

1 8 2 ⇒ 1800Ω = 1.8kΩ
 ————— Indicates number of zeros after effective number
 ————— 2-digit effective number, decimal point indicated by R.
 • Units: Ω

● **Capacitors**

Ex.: **CE** **04W** **1H** **2R2** **M** **BP**
 Type Shape and performance Dielectric strength Capacity Allowable error Others

CE : Aluminum foil electrolyte	0J : 6.3V	F : ±1%	HS : High stability type
CA : Aluminum solid electrolyte	1A : 10V	G : ±2%	BP : Non-polar type
CS : Tantalum electrolyte	1C : 16V	J : ±5%	HR : Ripple-resistant type
CQ : Film	1E : 25V	K : ±10%	DL : For charge and discharge
CK : Ceramic	1V : 35V	M : ±20%	HF : For assuring high frequency
CC : Ceramic	1H : 50V	Z : ±80%	U : UL part
CP : Oil	2A : 100V	20% : 20%	C : CSA part
CM : Mica	2B : 125V	P : +100%	W : UL-CSA type
CF : Metallized	2C : 160V	-0% : -0%	F : Lead wire forming
CH : Metallized	2D : 200V	C : ±0.25pF	
	2E : 250V	D : ±0.5pF	
	2H : 500V	= : Others	
	2J : 630V		

Capacity

2 R 2 ⇒ 2.2 μF
 ————— 1-digit effective number, decimal point indicated by R.
 ————— 2-digit effective number, decimal point indicated by R.

- Units: μF, (for P, pF (μμF))
- When the dielectric strength is indicated in AC, "AC" is included after the dielectric strength value.

PRINTED WIRING BOARD PARTS LIST
1U-2030A INPUT & CONTROL UNIT PARTS LIST
(For PMA-1060 Model)

Ref. No.	Part No.	Part Name	Remarks
SEMICONDUCTORS			
IC201	265 0030 004	NJM4558D-D	
IC301	263 0609 002	NJM2068DDC	
IC401	263 0711 000	M5218AP	
IC402	263 0654 002	NJM2082D	
IC701	265 0030 004	NJM4558D-D	
TR401,402	273 0317 906	2SC2458 (BL)	
TR601,602	273 0235 923	2SC1841 (E/F)	
TR603	269 0107 900	RN1241 (A/B)	
TR604,605	273 0317 906	2SC2458 (BL)	
TR606	271 0191 906	2SA1048 (GR)	
TR607	273 0235 923	2SC1841 (E/F)	
TR608	271 0131 924	2SA988 (E/F)	
TR610-612	273 0235 923	2SC1841 (E/F)	
TR701-704	275 0038 045	2SK369 (BL)/(GR)-C	
D301	276 0049 914	1S2076A	
D401,402	276 0049 914	1S2076A	
D601,602	276 0432 903	1SS270A	
D605-607	276 0432 903	1SS270A	
D701,702	276 0049 914	1S2076A	
D804	276 0432 903	1SS270A	
D811-814	276 0548 910	DSM1D2 (TYPE-3)	
ZD601	276 0465 925	HZS7B-3TD	
ZD805	276 0465 925	HZS7B-3TD	
ZD806	276 0477 913	HZS16-2TD	
LD301	393 9420 907	SEL4117R	
LD801	393 9155 007	SLP-171E (LED)	
SC601	279 0016 904	SF0R1A42	
RESISTORS(not included Carbon Film $\pm 5\%$, 1/4W Type)			
(Carbon Film)			
⚠ R607,608	241 2380 950	RD14B2E202JNBST	2k Ω , 1/4W (NB)
⚠ R611,612	241 2380 950	RD14B2E202JNBST	2k Ω , 1/4W (NB)
⚠ R901,902	241 2387 940	RD14B2E4R7JNBST	4.7 Ω , 1/4W (NB)
(Metal Oxide Film)			
⚠ R639-642	244 2051 929	RS14B3A821JST (S)	820 Ω , 1W
⚠ R643,644	244 2050 975	RS14B3A132JST (S)	1.3k Ω , 1W
⚠ R903,904	244 2043 937	RS14B3A100JST (S)	10 Ω , 1W
⚠ R905-908	244 2052 960	RS14B3A221JST (S)	220 Ω , 1W
(Metal Film)			
R301,302	245 2081 905	RN14K2E362G	3.6k Ω , 1/4W
R705,706	245 2044 900	RN14K2E101G	100 Ω , 1/4W
R707,708	245 2108 901	RN14K2E473G	47k Ω , 1/4W
R709,710	245 2020 908	RN14K2E100G	10 Ω , 1/4W
R711-714	245 2079 904	RN14K2E302G	3k Ω , 1/4W
R715,716	245 2051 906	RN14K2E201G	200 Ω , 1/4W
R717,718	245 2075 908	RN14K2E202G	2k Ω , 1/4W
R721,722	245 2042 902	RN14K2E820G	82 Ω , 1/4W
R723,724	245 2108 901	RN14K2E473G	47k Ω , 1/4W
R725,726	245 2082 904	RN14K2E392G	3.9k Ω , 1/4W

Ref. No.	Part No.	Part Name	Remarks
R727,728	245 2028 900	RN14K2E220G	22 Ω , 1/4W
R733,734	245 2052 905	RN14K2E221G	220 Ω , 1/4W
R735,736	245 2060 900	RN14K2E471G	470 Ω , 1/4W
R737	245 2066 904	RN14K2E821G	820 Ω , 1/4W
(Variable)			
VR201	211 0654 001	V1620P30FW104K	100k Ω , BALANCE
VR202	211 0653 002	V1620P30FD103K	10k Ω , TREBLE
VR203	211 0653 015	V1620P30FD303K	30k Ω , BASS
VR301	211 0656 009	V1620V20FB303T	30k Ω MAIN VOL
CAPACITORS			
(Ceramic)			
C101-110	253 4537 982	CC45SL1H560J (DD-3)	56pF/50V
C112	253 1148 905	CK45F1H223Z	0.022 μ F/50V
C113	253 1146 907	CK45F1H103Z	0.01 μ F/50V
C207,208	253 4538 907	CC45SL1H680J (DD-3)	68pF/50V
C237,238	253 4537 924	CC45SL1H330J (DD-3)	33pF/50V
C307,308	253 4535 955	CC45SL1H050C (DD-3)	5pF/50V
C309	253 1146 907	CK45F1H103Z	0.01 μ F/50V
C311	253 1146 907	CK45F1H103Z	0.01 μ F/50V
C403	253 4538 949	CC45SL1H101J (DD-3)	100pF/50V
C405	253 4538 949	CC45SL1H101J (DD-3)	100pF/50V
C406	253 1146 907	CK45F1H103Z	0.01 μ F/50V
C408	253 1146 907	CK45F1H103Z	0.01 μ F/50V
C601,602	253 1146 907	CK45F1H103Z	0.01 μ F/50V
C606	253 1148 905	CK45F1H223Z	0.022 μ F/50V
C702	253 1148 905	CK45F1H223Z	0.022 μ F/50V
C703,704	253 4537 966	CC45SL1H470J (DD-3)	47pF/50V
C705,706	253 1179 929	CK45B1H151K (DD-3)	150pF/50V
⚠ C811	253 8014 702	CK45F2GAC103MC	0.01 μ F/400V AC
(Electrolytic)			
C111	254 4260 948	CE04W1H010M (SME)	1 μ F/50V
C201	254 4260 906	CE04W1H0R1M (SME)	0.1 μ F/50V
C202	254 4196 902	CE04W1H0R1M (SRA)	0.1 μ F/50V
C203	254 4260 906	CE04W1H0R1M (SME)	0.1 μ F/50V
C204	254 4196 902	CE04W1H0R1M (SRA)	0.1 μ F/50V
C205	254 4260 948	CE04W1H010M (SME)	1 μ F/50V
C206	254 4196 944	CE04W1H010M (SRA)	1 μ F/50V
C217,218	254 4254 909	CE04W1C100M (SME)	10 μ F/16V
C221,222	254 4260 919	CE04W1HR22M (SME)	0.22 μ F/50V
C223,224	254 4260 906	CE04W1H0R1M (SME)	0.1 μ F/50V
C225,226	254 4260 935	CE04W1HR47M (SME)	0.47 μ F/50V
C227,228	254 4260 922	CE04W1HR33M (SME)	0.33 μ F/50V
C233	254 4260 948	CE04W1H010M (SME)	1 μ F/50V
C235	254 4196 944	CE04W1H010M (SRA)	1 μ F/50V
C305,306	254 4260 948	CE04W1H010M (SME)	1 μ F/50V
C315,316	254 4254 909	CE04W1C100M (SME)	10 μ F/16V
C323	254 4260 948	CE04W1H010M (SME)	1 μ F/50V
C401,402	254 4260 948	CE04W1H010M (SME)	1 μ F/50V
C404	254 4260 980	CE04W1H100M (SME)	10 μ F/50V
C407	254 4260 993	CE04W1H220M (SME)	22 μ F/50V

Ref. No.	Part No.	Part Name	Remarks
C603	254 4250 945	CE04W0J331M (SME)	330μF/6.3V
C604	254 4252 930	CE04W1A101M (SME)	100μF/10V
C605	254 4252 901	CE04W1A220M (SME)	22μF/10V
C701	254 4260 948	CE04W1H010M (SME)	1μF/50V
C713,714	254 4252 930	CE04W1A101M (SME)	100μF/10V
C715,716	254 4254 909	CE04W1C100M (SME)	10μF/16V
C727,728	254 4260 948	CE04W1H010M (SME)	1μF/50V
C731	254 4252 930	CE04W1A101M (SME)	100μF/10V
C813,814	254 4289 770	CE04W1H102MC (AWF)	1000μF/50V
(Plastic Film)			
C115,116	255 4199 986	CQ92M1H102J (MRZ)	1000pF/50V
C707,708	255 6178 963	CQ09S1H102J (SMT)	1000pF/50V
C709,710	255 6177 948	CQ09S1H101J (SMT)	100PF/50V
C711,712	255 6179 920	CQ09S1H332J (SMT)	3300pF/50V
C719,720	255 6178 976	CQ09S1H122J (SMT)	1200pF/50V
C721,722	255 4199 957	CQ92M1H183J (MRZ)	0.018μF/50V
C723,724	255 4199 986	CQ92M1H102J (MRZ)	1000pF/50V
C901,902	255 4228 996	CQ92P2A223J	0.022μF/100V
C907,908	255 4228 938	CQ92P2A472J	4700pF/100V
C911,912	255 4228 938	CQ92P2A472J	4700pF/100V
(Metalized)			
C219,220	256 1034 911	CF93A1H333J	0.033μF/50V
C229,230	256 1034 953	CF93A1H683J	0.068μF/50V
C231,232	256 1034 911	CF93A1H333J	0.033μF/50V
C717,718	256 1034 953	CF93A1H683J	0.068μF/50V
C815	256 1042 903	CF93A2E104K	0.1μF/250V
SWITCHES, RELAYS, COILS			
L701-704	235 9003 002	FTZ CHOKE COIL	150μH
L901,902	235 0068 004	INDUCTOR	1μH
RL301	214 0127 003	RELAY (RY-12W)	PRE OUT
RL601,602	214 0129 001	RELAY (DH2TU)	SP
RL603	214 0127 003	RELAY (RY-12W)	H/P
SW101	212 4331 006	SLIDE SW (4-6)	REC OUT
		REMOTE	
SW102	212 1035 004	SLIDE SW (2-6)	INPUT
		REMOTE	
SW201-203	212 1037 002	3P PUSH SWITCH	MUTE, SUB, LOUD
SW301	212 1040 002	1P PUSH SWITCH	S. DIRECT
SW601	212 0322 006	ROTARY SWITCH	SP. SW
SW701	212 1041 001	1P PUSH SWITCH	MM-MC SW
▲ SW801	212 1031 008	POWER SWITCH (TV-5)	
OTHER PARTS			Q'ty
	202 0022 008	FUSE HOLDER	6
▲ F801	206 1015 087	FUSE (4.0A)	1
▲ F802,803	206 1015 029	FUSE (1A)	2
	415 0299 000	CONDENSER COVER	1

Ref. No.	Part No.	Part Name	Remarks	Q'ty
	204 8354 004	HEADPHONE JACK		1
	205 0274 004	2P CONN. BASE		2
	204 8266 008	4P PIN JACK (S-GND)		2
	204 8300 003	6P PIN JACK		1
	205 0471 001	8P TERMINAL	SP.	1
	205 0185 025	2P WIRE HOLDER		1
	205 0185 054	5P WIRE HOLDER		8
	205 0233 032	3P EH CONN. BASE		1
	205 0277 030	3P EH CONN. BASE (RED)		1
	205 0233 058	5P EH CONN. BASE		1
	205 0277 056	5P EH CONN. BASE (RED)		1
	205 0276 057	5P EH CONN. BASE (BLUE)		1
	203 2265 002	2P SIN CORD Ass'y	CN2A	1
	203 4706 006	3P EH CONN. CORD	CN3C	1
	203 4706 019	3P EH CONN. CORD Ass'y	CN3E	1
	203 4716 009	3P SCN-SCN CONN. CORD	CN3D	1
	203 4716 012	3P SCN-SCN CONN. CORD	CN3B	1
	002 0015 017	5C RIBBON CABLE	CN5E	1
	002 0015 020	5C RIBBON CABLE	CN5B	1
	002 0007 025	5C RIBBON CABLE	CN5C	1
	203 8244 014	5P EH CONN. CORD (RED)	CN5A	1
	205 0233 061	6P EH CONN. BASE		1
	203 8283 004	5P EH CONN. CORD (BLUE)	CN5F	1
	415 0546 012	UL TUBE (8.3) BK	CN5B,5C	2

**1U-2030B INPUT & CONTROL UNIT PARTS LIST
(for Europe Gold Version)**

[Same as 1U-2030A (for Europe Black Version) except the followings]

Ref. No.	Part No.	Part Name	Remarks	Q'ty
OTHER PARTS				
	204 8355 003	HEADPHONE JACK	CHANGE	1

1U-2030C INPUT & CONTROL UNIT PARTS LIST
(for Multi-Voltage Black Version)
 [Same as 1U-2030A (for Europe Black Version) except the followings]

Ref. No.	Part No.	Part Name	Remarks	
CAPACITORS				
(Ceramic)				
C101~110	253 4537 982	CC45SL1H560J (DD-3)	DELETE	
C112	253 1148 905	CK45F1H223Z	DELETE	
C237,238	253 4537 924	CC45SL1H330J (DD-3)	DELETE	
C702	253 1148 905	CK45F1H223Z	DELETE	
C703,704	253 4537 966	CC45SL1H470J (DD-3)	DELETE	
△ C811	253 8014 702	CK45F2GAC103MC	DELETE	
(Plastic Film)				
C707,708	255 6178 963	CQ09S1H102J (SMT)	DELETE	
C709,710	255 6177 948	CQ09S1H101J (SMT)	DELETE	
SWITCH, COILS				
L701~704	235 9003 002	FTZ CHOKE COIL	DELETE	
△ SW801	212 1031 008	POWER SWITCH (TV-5)	DELETE	
OTHER PARTS				Q'ty
△ F801	205 0467 002	8P TERMINAL	CHANGE	1
	206 1015 087	FUSE (4.0A)	DELETE	1
△ F802,803	206 1060 074	FUSE 1A (250V)	CHANGE	2
	202 0022 008	FUSE HOLDER	CHANGE	4
	415 0299 000	CONDENSER COVER	DELETE	1

1U-2030E INPUT & CONTROL UNIT PARTS LIST
(for U.S.A., Canada Black Version)
 [Same as 1U-2030A (for Europe Black Version) except the followings]

Ref. No.	Part No.	Part Name	Remarks	
CAPACITORS				
(Ceramic)				
C101~110	253 4537 982	CC45SL1H560J (DD-3)	DELETE	
C112	253 1148 905	CK45F1H223Z	DELETE	
C237,238	253 4537 924	CC45SL1H330J (DD-3)	DELETE	
C702	253 1148 905	CK45F1H223Z	DELETE	
C703,704	253 4537 966	CC45SL1H470J (DD-3)	DELETE	
△ C811	253 8014 702	CK45F2GAC103MC	DELETE	
(Plastic Film)				
C707,708	255 6178 963	CQ09S1H102J (SMT)	DELETE	
C709,710	255 6177 948	CQ09S1H101J (SMT)	DELETE	
SWITCH, COILS				
L701~704	235 9003 002	FTZ CHOKE COIL	DELETE	
△ SW801	212 1031 008	POWER SWITCH (TV-5)	DELETE	
OTHER PARTS				Q'ty
△ F801	205 0467 002	8P TERMINAL	CHANGE	1
	206 1015 087	FUSE (4.0A)	DELETE	1
△ F802,803	206 1039 034	FUSE 1A	CHANGE	2
	513 1674 067	FUSE LABEL	ADD	2
	415 0299 000	CONDENSER COVER	DELETE	1
	202 0022 008	FUSE HOLDER	CHANGE	4

1U-2030D INPUT & CONTROL UNIT PARTS LIST
(for U.K., Australia Black Version)
 [Same as 1U-2030A (for Europe Black Version) except the followings]

Ref. No.	Part No.	Part Name	Remarks	
OTHER PARTS				Q'ty
	205 0467 002	8P TERMINAL (S.P. TERMINAL)	CHANGE	1

1U-2031A P. AMP & SUPPLY UNIT PARTS LIST
(For PMA-1060 Model)

Ref. No.	Part No.	Part Name	Remarks
SEMICONDUCTORS			
IC501,502	262 0874 009	TLP 521-1 (BL)	
TR501-504	275 0055 015	2SK184C (GR)/(BL)	
TR505-508	273 0235 923	2SC1841 (E/F)	
TR509-514	271 0168 900	2SA1145 (O)/(Y)	
TR515,516	273 0281 906	2SC2705 (O)/(Y)	
TR517,518	273 0198 002	2SC1815 (Y)	
TR519,520	274 0158 003	2SD1763A (D)	
TR521,522	272 0115 008	2SB1186A (B)	
TR801	273 0198 918	2SC1815 (BL)	
TR802	271 0102 908	2SA1015 (Y)	
TR803	274 0136 012	2SD1913 (R/S)	
TR804	272 0093 010	2SB1274 (R/S)	
TR805,806	275 0043 946	2SK381 (C)	
D501-522	276 0049 914	1S2076A	
D801	276 0424 005	4D4B42 (LCI)	
D802,803	276 0553 905	1SR35-200A (T93X)	
ZD501-504	276 0236 934	HZ5C-1	
ZD803,804	276 0249 905	HZ18-2	
RESISTORS (not included Carbon Film ±5%, 1/4W Type)			
(Carbon Film)			
△ R519-522	241 2315 983	RD14B2E331FRT	330Ω, 1/4W Fuse Resistor
△ R523-526	241 2376 922	RD14B2E330JNBST	33Ω, 1/4W Non-Burning Type
△ R527,528	241 2380 918	RD14B2E132JNBST	1.3kΩ, 1/4W Non-Burning Type
△ R529,530	241 2377 921	RD14B2E820JNBST	82Ω, 1/4W Non-Burning Type
△ R531-534	241 2371 930	RD14B2E161FRT	160Ω, 1/4W Fuse Resistor
△ R549,550	241 2378 904	RD14B2E181JNBST	180Ω, 1/4W Non-Burning Type
(Wire Wound)			
△ R561-568	243 2039 029	RW99-3HR22K	0.22Ω, 5W
(Metal Oxide Film)			
△ R573,574	244 2050 904	RS14B3A220JST (S)	22Ω, 1W
(Metal Film)			
R503,504	245 2044 900	RN14K2E101GT	100Ω, 1/4W
R505-508	245 2084 902	RN14K2E472GT	4.7kΩ, 1/4W
R509,510	245 2044 900	RN14K2E101GT	100Ω, 1/4W
R511,512	245 2090 909	RN14K2E822GT	8.2kΩ, 1/4W
R513,514	245 2044 900	RN14K2E101GT	100Ω, 1/4W
R517,518	245 2099 900	RN14K2E203GT	20kΩ, 1/4W
R535,536	245 2068 902	RN14K2E102GT	1kΩ, 1/4W
R537,538	245 2084 902	RN14K2E472GT	4.7kΩ, 1/4W
R539,540	245 2103 906	RN14K2E303GT	30kΩ, 1/4W
R543,544	245 2096 903	RN14K2E153GT	15kΩ, 1/4W

Ref. No.	Part No.	Part Name	Remarks
R569,570	245 2060 900	RN14K2E471GT	470Ω, 1/4W
R597,598	245 2116 906	RN14K2E104GT	100kΩ, 1/4W
R817,818	245 2380 907	RN14K2E684GT	680kΩ, 1/4W
R819,820	245 2134 904	RN14K2E564GT	560kΩ, 1/4W
(Variable)			
VR501,502	211 6077 941	V06PB502	5kΩ Semifixed Resistor
VR503,504	211 6077 983	V06PB473	47kΩ, Semifixed Resistor
CAPACITORS			
(Ceramic)			
C519,520	253 1179 945	CK45B1H221KT (DD-3)	220pF/50V
(Electrolytic)			
C507,508	254 4356 739	CE04W1H470MC (ARS)	47μF/50V
C525,526	254 4262 904	CE04W1J4R7MT (SME)	4.7μF/63V
C535,536	254 4356 713	CE04W1H101MC (ARS)	100μF/50V
C545,546	254 4262 904	CE04W1J4R7MT (SME)	4.7μF/63V
C801,802	254 4261 921	CE04W1H101MT (SME)	100μF/50V
C803,804	254 4356 713	CE04W1H101MC (ARS)	100μF/50V
△ C805-808	254 4370 702	CE04W1J822MC (DL)	8200μF/63V
C810	254 4180 950	CE04W1J2R2MT (SM)	2.2μF/63V
(Plastic Film)			
C501-504	255 6177 948	CQ09S1H101JT (SMT)	100pF/50V
C505,506	255 6178 963	CQ09S1H102JT (SMT)	1000pF/50V
C509,510	255 6152 031	CQ09S2E270J	27pF/250V
C527,528	255 6152 099	CQ09S2E100J	10pF/250V
C529,530	255 6178 905	CQ09S1H331JT (SMT)	330pF/50V
C531,532	255 4228 996	CQ92P2A223JT	0.022μF/100V
C533,534	255 6152 073	CQ09S2E560J	56pF/250V
C541,542	255 4228 967	CQ92P2A103JT	0.01μF/100V
(Metalized)			
C809	256 1042 000	CF93A2E104K	0.1μF/250V
C817,818	256 1042 013	CF93A2E105K	1μF/250V
OTHER PARTS GROUP			
	417 0401 001	RADIATOR	1
	473 8007 009	3x12 CUP SCREW	1
	205 0190 036	3P NH CONN.	TP001,002 2
	205 0233 032	BASE 3P EH CONN.	1
	205 0185 054	BASE 5P WIRE HOLDER	1
	203 4705 007	3P EH-SCN CORD (RED)	CN3A 1
	203 8218 082	5P EH-CON CORD	CN5D 1
	204 0309 002	6P EH-SCN CONN. CORD	CN6A 1

1U-2031C P.AMP & SUPPLY UNIT PARTS LIST (for Multi-Voltage Black Version)

[Same as 1U-2031A (for Europe Black Version) except the followings]

Ref. No.	Part No.	Part Name	Remarks
CAPACITORS			
(Metalized)			
C817,818	256 1042 013	CF93A2E105K	DELETE

1U-2031E P.AMP & SUPPLY UNIT PARTS LIST (for U.S.A. Black Version)

[Same as 1U-2031A (for Europe Black Version) except the followings]

Ref. No.	Part No.	Part Name	Remarks	Q'ty
RESISTORS				
(Carbon Film)				
△ R691-694	241 2314 049	RD14B2E100JNBF	10Ω, 1/4W (NB) ADD	4
CAPACITORS				
(Metalized)				
C525,526	256 1042 903	CF93A2E104K	0.1μF/250V CHANGE	2
C545,546	256 1042 903	CF93A2E104K	0.1μF/250V CHANGE	2
C817,818	256 1042 013	CF93A2E105K	DELETE	2
OTHER PARTS				
	203 8287 000	5P EH-SCN CONN. CORD	CN5D CHANGE	1
	204 0310 004	6P EH-SCN CONN. CORD	CN6A CHANGE	1
	205 0185 054	5P WIRE HOLDER	DELETE	1

1U-2031F P.AMP & SUPPLY UNIT PARTS LIST (for Canada Black Version)

[Same as 1U-2031A (for Europe Black Version) except the followings]

Ref. No.	Part No.	Part Name	Remarks	Q'ty
CAPACITORS				
(Metalized)				
C817,818	256 1042 013	CF93A2E105K	DELETE	2
OTHER PARTS				
	203 8287 000	5P EH-SCN CONN. CORD	CN5D CHANGE	1
	204 0310 004	6P EH-SCN CONN. CORD	CN6A CHANGE	1
	205 0185 054	5P WIRE HOLDER	DELETE	1

1U-2092C POWER SWITCH UNIT PARTS LIST

(For PMA-1060 Model)

Ref. No.	Part No.	Part Name	Remarks	Q'ty
CAPACITORS				
(Ceramic)				
△ C811	253 8014 702	CK45F2GAC103MC	0.01μF/400V AC	1
SWITCH				
△ SW801	212 9534 002	POWER SW (PUSH) TV-8		1
OTHER PARTS				
	202 0022 008	FUSE HOLDER		4
△ F801	206 1061 073	FUSE 10A (250V)		1
△ F804	206 1061 044	FUSE 5A (250V)		1
	415 0299 000	CONDENSER COVER		1

1U-2092E POWER SWITCH UNIT PARTS LIST (for U.S.A., Canada)

Ref. No.	Part No.	Part Name	Remarks	Q'ty
CAPACITORS				
(Ceramic)				
△ C811	253 8014 702	CK45F2GAC103MC	0.01μF/125V AC	1
SWITCH				
△ SW801	212 9534 002	POWER SW (PUSH) TV-8		1
OTHER PARTS				
	202 0022 008	FUSE HOLDER		2
	513 1673 026	FUSE CAUTION LABEL		1
△ F801	206 1046 043	FUSE 10A		1

1U-2028A INPUT & CONTROL UNIT PARTS LIST
(For PMA-860 Model)

Ref. No.	Part No.	Part Name	Remarks
SEMICONDUCTORS			
IC201	265 0030 004	NJM4558D-D	
IC401	263 0711 000	M5218AP	
IC402	263 0654 002	NJM2082D	
IC701	265 0030 004	NJM4558D-D	
TR401,402	273 0317 906	2SC2458 (BL)	
TR601,602	273 0235 923	2SC1841 (E/F)	
TR603	269 0107 900	RN1241 (A/B)	
TR604,605	273 0317 906	2SC2458 (BL)	
TR606	271 0191 906	2SA1048 (GR)	
TR607	273 0235 923	2SC1841 (E/F)	
TR608	271 0131 924	2SA988 (E/F)	
TR610-612	273 0235 923	2SC1841 (E/F)	
TR701-704	275 0038 045	2SK369 (BL)/(GR)-C	
D401,402	276 0049 914	1S2076A	
D601,602	276 0432 903	1SS270A	
D605-607	276 0432 903	1SS270A	
D701,702	276 0049 914	1S2076A	
D804	276 0432 903	1SS270A	
ZD601	276 0465 925	HZS7B-3TD	
ZD805	276 0465 925	HZS7B-3TD	
ZD806	276 0474 916	HZS12B-2TD	
LD301	393 9420 907	SEL4117R	
LD801	393 9155 007	SLP-171E (LED)	
SC601	279 0016 904	SF0R1A42	
RESISTORS (not included Carbon Film ±5%, 1/4W Type)			
(Carbon Film)			
▲ R607,608	241 2380 950	RD14B2E202JNBST	2kΩ, 1/4W (NB)
▲ R611,612	241 2380 950	RD14B2E202JNBST	2kΩ, 1/4W (NB)
▲ R901,902	241 2387 940	RD14B2E4R7JNBST	4.7Ω, 1/4W (NB)
(Metal Oxide Film)			
▲ R639-642	244 2043 908	RS14B3A681JST (S)	680Ω, 1W
▲ R643	244 2052 915	RS14B3A182JST (S)	1.8kΩ, 1W
▲ R644	244 2052 944	RS14B3A152JST (S)	1.5kΩ, 1W
▲ R903,904	244 2043 937	RS14B3A100JST (S)	10Ω, 1W
▲ R905-908	244 2052 960	RS14B3A221JST (S)	220Ω, 1W
(Metal Film)			
R301,302	245 2081 905	RN14K2E362G	3.6kΩ, 1/4W
R705,706	245 2044 900	RN14K2E101G	100Ω, 1/4W
R707,708	245 2108 901	RN14K2E473G	47kΩ, 1/4W
R709,710	245 2020 908	RN14K2E100G	10Ω, 1/4W
R711-714	245 2079 904	RN14K2E302G	3kΩ, 1/4W
R715,716	245 2051 906	RN14K2E201G	200Ω, 1/4W
R717,718	245 2075 908	RN14K2E202G	2kΩ, 1/4W
R721,722	245 2042 902	RN14K2E820G	82Ω, 1/4W
R723,724	245 2108 901	RN14K2E473G	47kΩ, 1/4W
R725,726	245 2082 904	RN14K2E392G	3.9kΩ, 1/4W
R727,728	245 2028 900	RN14K2E220G	22Ω, 1/4W
R733,734	245 2052 905	RN14K2E221G	220Ω, 1/4W

Ref. No.	Part No.	Part Name	Remarks
R735,736	245 2060 900	RN14K2E471G	470Ω, 1/4W
R737	245 2066 904	RN14K2E821G	820Ω, 1/4W
(Variable)			
VR201	211 0654 001	V1620P30FW104K	100kΩ BALANCE
VR202	211 0653 002	V1620P30FD103K	10kΩ, TREBLE
VR203	211 0653 015	V1620P30FD303K	30kΩ, BASS
VR301	211 0656 009	V1620V20FB303T	30kΩ, MAIN VOL.
CAPACITORS			
(Ceramic)			
C101-110	253 4537 982	CC45SL1H560J (DD-3)	56pF/50V
C112	253 1148 905	CK45F1H223Z	0.022μF/50V
C113	253 1146 907	CK45F1H103Z	0.01μF/50V
C207,208	253 4538 907	CC45SL1H680J (DD-3)	68pF/50V
C237,238	253 4537 924	CC45SL1H330J (DD-3)	33pF/50V
C403	253 4538 949	CC45SL1H101J (DD-3)	100pF/50V
C405	253 4538 949	CC45SL1H101J (DD-3)	100pF/50V
C406	253 1146 907	CK45F1H103Z	0.01μF/50V
C408	253 1146 907	CK45F1H103Z	0.01μF/50V
C601,602	253 1146 907	CK45F1H103Z	0.01μF/50V
C606	253 1148 905	CK45F1H223Z	0.022μF/50V
C702	253 1148 905	CK45F1H223Z	0.022μF/50V
C703,704	253 4537 966	CC45SL1H470J (DD-3)	47pF/50V
C705,706	253 1179 929	CK45B1H151K (DD-3)	150PF/50V
▲ C811	253 8014 702	CK45F2GAC103MC	0.01μF/400V AC
C903,904	253 1179 961	CK45B1H331KT (DD-3)	330pF/50V
(Electrolytic)			
C111	254 4260 948	CE04W1H010M (SME)	1μF/50V
C201	254 4260 906	CE04W1H0R1M (SME)	0.1μF/50V
C202	254 4196 902	CE04W1H0R1M (SRA)	0.1μF/50V
C203	254 4260 906	CE04W1H0R1M (SME)	0.1μF/50V
C204	254 4196 902	CE04W1H0R1M (SRA)	0.1μF/50V
C205	254 4260 948	CE04W1H010M (SME)	1μF/50V
C206	254 4196 944	CE04W1H010M (SRA)	1μF/50V
C217,218	254 4254 909	CE04W1C100M (SME)	10μF/16V
C221,222	254 4260 919	CE04W1HR22M (SME)	0.22μF/50V
C223,224	254 4260 906	CE04W1H0R1M (SME)	0.1μF/50V
C225,226	254 4260 935	CE04W1HR47M (SME)	0.47μF/50V
C227,228	254 4260 922	CE04W1HR33M (SME)	0.33μF/50V
C233	254 4260 948	CE04W1H010M (SME)	1μF/50V
C235	254 4196 944	CE04W1H010M (SRA)	1μF/50V
C401,402	254 4260 948	CE04W1H010M (SME)	1μF/50V
C404	254 4260 980	CE04W1H100M (SME)	10μF/50V
C407	254 4260 993	CE04W1H220M (SME)	22μF/50V
C603	254 4250 945	CE04W0J331M (SME)	330μF/6.3V
C604	254 4252 930	CE04W1A101M (SME)	100μF/10V
C605	254 4252 901	CE04W1A220M (SME)	22μF/10V
C701	254 4260 948	CE04W1H010M (SME)	1μF/50V
C713,714	254 4252 930	CE04W1A101M (SME)	100μF/10V
C715,716	254 4254 909	CE04W1C100M (SME)	10μF/16V
C727,728	254 4260 948	CE04W1H010M (SME)	1μF/50V
C731	254 4252 930	CE04W1A101M (SME)	100μF/10V

Ref. No.	Part No.	Part Name	Remarks
(Plastic Film)			
C115,116	255 4199 986	CQ92M1H102J (MRZ)	1000PF/50V
C707,708	255 6178 963	CQ09S1H102J (SMT)	1000pF/50V
C709,710	255 6177 948	CQ09S1H101J (SMT)	100PF/50V
C711,712	255 6179 920	CQ09S1H332J (SMT)	3300pF/50V
C719,720	255 6178 976	CQ09S1H122J (SMT)	1200PF/50V
C721,722	255 4199 957	CQ92M1H183J (MRZ)	0.018μF/50V
C723,724	255 4199 986	CQ92M1H102J (MRZ)	1000pF/50V
C901,902	255 4199 960	CQ92M1H223JT (MRZ)	0.022μF/50V
C907,908	255 4199 973	CQ92M1H103JT (MRZ)	0.01μF/50V
C911,912	255 4199 973	CQ92M1H103JT (MRZ)	0.01μF/50V
(Metalized)			
C219,220	256 1034 911	CF93A1H333J	0.033μF/50V
C229,230	256 1034 953	CF93A1H683J	0.068μF/50V
C231,232	256 1034 911	CF93A1H333J	0.033μF/50V
C717,718	256 1034 953	CF93A1H683J	0.068μF/50V
SWITCHES, RELAYS, COILS			
L701-704	235 9003 002	FTZ CHOKE COIL	150μH
L901,902	235 0068 004	INDUCTOR	1μH
RL601,602	214 0129 001	RELAY (DH2TU)	S.P.
RL603	214 0127 003	RELAY (RY-12W)	H/P
SW101	212 4331 006	SLIDE SW (4-6)	REC OUT
		REMOTE	
SW102	212 1035 004	SLIDE SW (2-6)	INPUT
		REMOTE	
SW202,203	212 1038 001	2P PUSH SWITCH	SUB, LOUD
SW301	212 1040 002	1P PUSH SWITCH	S. DIRECT
SW601	212 0322 006	ROTARY SWITCH	SP SW
SW701	212 1041 001	1P PUSH SWITCH	MM-MC SW
▲ SW801	212 1031 008	POWER SWITCH (TV-5)	
OTHER PARTS			
			Q'ty
▲ F801	202 0022 008	FUSE HOLDER	2
	206 1015 074	FUSE (3.15A)	1
	415 0299 000	CONDENSER COVER	1
	204 8354 004	HEADPHONE JACK	1
	205 0274 004	2P CONN. BASE	1
	204 8266 008	4P PIN JACK (S-GND)	2
	204 8300 003	6P PIN JACK	1
	205 0484 001	8P SP TERMINAL (E2)	1
	205 0185 025	2P WIRE HOLDER	1
	205 0185 054	5P WIRE HOLDER	7
	205 0233 032	3P EH CONN. BASE	1
	205 0277 030	3P EH CONN. BASE (RED)	1
	205 0233 058	5P EH CONN. BASE	1
	205 0277 056	5P EH CONN. BASE (RED)	1
	205 0233 061	6P EH CONN. BASE	1
	203 2265 002	2P SIN CORD ASS'Y	CN2A 1
	203 4706 006	3P EH CONN. CORD	CN3C 1
	203 4706 019	3P EH CONN. CORD Ass'y	CN3E 1

Ref. No.	Part No.	Part Name	Remarks	Q'ty
	203 4716 009	3P SCN-SCN CONN. CORD	CN3D	1
	203 4716 012	3P SCN-SCN CONN. CORD	CN3B	1
	002 0015 017	5C RIBBON CABLE	CN5E	1
	002 0015 020	5C RIBBON CABLE	CN5B	1
	002 0007 025	5C RIBBON CABLE	CN5C	1
	203 8244 014	5P EH CONN. CORD (RED)	CN5A	1
	415 0546 012	UL TUBE (8.3) BK	CN5B,5C	2

1U-2028B INPUT & CONTROL UNIT PARTS LIST (for Europe Gold Version)
 [Same as 1U-2028A (for Europe Black Version) except the followings]

Ref. No.	Part No.	Part Name	Remarks	Q'ty
OTHER PARTS				
	204 8355 003	HEADPHONE JACK	CHANGE	1

1U-2028C INPUT & CONTROL UNIT PARTS LIST (for Multi-Voltage, U.S.A., Canada Black Version)
 [Same as 1U-2028A (for Europe Black Version) except the followings]

Ref. No.	Part No.	Part Name	Remarks
CAPACITORS			
(Ceramic)			
C101-110	253 4537 982	CC45SL1H560J (DD-3)	DELETE
C112	253 1148 905	CK45F1H223Z	DELETE
C237,238	253 4537 924	CC45SL1H330J (DD-3)	DELETE
C702	253 1148 905	CK45F1H223Z	DELETE
C703,704	253 4537 966	CC45SL1H470J (DD-3)	DELETE
▲ C811	253 8014 702	CK45F2GAC103MC	DELETE
C903,904	253 1179 961	CK45B1H331K (DD-3)	DELETE
(Plastic Film)			
C707,708	255 6178 963	CQ09S1H102J (SMT)	DELETE
C709,710	255 6177 948	CQ09S1H101J (SMT)	DELETE
SWITCH, COILS			
L701-704	235 9003 002	FTZ CHOKE COIL	DELETE
▲ SW801	212 1031 008	POWER SWITCH (TV-5)	DELETE
OTHER PARTS			
			Q'ty
▲ F801	205 0472 000	8P SP TERMINAL	CHANGE 1
	206 1015 074	FUSE (3.15A)	DELETE 1
	202 0022 008	FUSE HOLDER	DELETE 2
	415 0299 000	CONDENSER COVER	DELETE 1

**1U-2028D INPUT & CONTROL UNIT PARTS LIST
(for U.K., Australia Black Version)**

[Same as 1U-2028A (for Europe Black Version) except the followings]

Ref. No.	Part No.	Part Name	Remarks	Q'ty
OTHER PARTS				
	205 0472 013	8P SP TERMINAL	CHANGE	1

**1U-2029A P. AMP & SUPPLY UNIT PARTS LIST
(For PMA-860 Model)**

Re. No.	Part No.	Part Name	Remarks
SEMICONDUCTORS			
IC501,502	262 0874 009	TLP521-1 (BL)	
TR501-504	275 0055 015	2SK184C (GR)/(BL)	
TR505-508	273 0235 923	2SC1841 (E/F)	
TR509-514	271 0131 924	2SA988 (E/F)	
TR515,516	273 0235 923	2SC1841 (E/F)	
TR517,518	273 0198 002	2SC1815 (Y)	
TR519,520	274 0151 000	2SD2004 (P)	
TR521,522	272 0107 906	2SB1328 (P)	
TR801	273 0235 923	2SC1841 (E/F)	
TR802	271 0131 924	2SA988 (E/F)	
TR803	274 0136 012	2SD1913 (R/S)	
TR804	272 0093 010	2SB1274 (R/S)	
TR805,806	275 0043 946	2SK381 (C)	
D501-522	276 0049 914	1S2076A	
D801	276 0424 005	4D4B42 (LC1)	
D802,803	276 0553 905	1SR35-200A (T93X)	
ZD501-504	276 0236 934	HZ5C-1	
ZD801,802	276 0485 921	HZS36-3	
ZD803,804	276 0249 905	HZ18-2	
RESISTORS (not included Carbon Film ±5%, 1/4W Type)			
(Carbon Film)			
△ R519-522	241 2315 983	RD14B2E331FRT	330Ω, Fuse Resistor
△ R523-526	241 2376 922	RD14B2E330JNBST	33Ω, Non-Burning Type
△ R527,528	241 2380 918	RD14B2E132JNBST	1.3kΩ, Non-Burning Type
△ R529,530	241 2377 921	RD14B2E820JNBST	82Ω, Non-Burning Type
△ R531-534	241 2371 930	RD14B2E161FRT	160Ω, Fuse Resistor
△ R549,550	241 2378 920	RD14B2E221JNBST	220Ω, Non-Burning Type
△ R801,802	241 2387 940	RD14B2E4R7JNBST	4.7Ω, 1/4W, Non-Burning Type
(Metal Oxide Film)			
△ R561-568	244 2043 982	RS14B3AR22JST (S)	0.22Ω, 1W
△ R573,574	244 2050 904	RS14B3A220JST (S)	22Ω, 1W
△ R803-806	244 2043 908	RS14B3A681JST (S)	680Ω, 1W

Ref. No.	Part No.	Part Name	Remarks
(Metal Film)			
R503,504	245 2060 900	RN14K2E471GT	470Ω, 1/4W
R505-508	245 2084 902	RN14K2E472GT	4.7kΩ, 1/4W
R509,510	245 2044 900	RN14K2E101GT	100Ω, 1/4W
R511,512	245 2090 909	RN14K2E822GT	8.2kΩ, 1/4W
R513,514	245 2046 908	RN14K2E121GT	120Ω, 1/4W
R517,518	245 2099 900	RN14K2E203GT	20kΩ, 1/4W
R535,536	245 2068 902	RN14K2E102GT	1kΩ, 1/4W
R537,538	245 2084 902	RN14K2E472GT	4.7kΩ, 1/4W
R539,540	245 2105 904	RN14K2E363GT	36kΩ, 1/4W
R543,544	245 2096 903	RN14K2E153GT	15kΩ, 1/4W
R569,570	245 2060 900	RN14K2E471GT	470Ω, 1/4W
R597,598	245 2116 906	RN14K2E104GT	100kΩ, 1/4W
(Variable)			
VR501,502	211 6077 941	V06PB502	5kΩ Semifixed Resistor
VR503,504	211 6077 983	V06PB473	47kΩ Semifixed Resistor
CAPACITORS			
(Ceramic)			
C509,510	253 4422 903	CC45SL1H270J	27pF/50V
C519,520	253 1179 945	CK45B1H221KT (DD-3)	220pF/50V
C527,528	253 4500 906	CC45SL2H150KT	15pF/500V
C529,530	253 4538 949	CC45SL1H101JT (DD-3)	100pF/50V
C533,534	253 4538 949	CC45SL1H101JT (DD-3)	100pF/50V
(Electrolytic)			
C507,508	254 4260 977	CE04W1H4R7M (SME)	4.7μF/50V
C525,526	254 4262 904	CE04W1J4R7MT (SME)	4.7μF/63V
C531,532	254 4260 948	CE04W1H010MT (SME)	1μF/50V
C535,536	254 4260 948	CE04W1H010MT (SME)	1μF/50V
C545,546	254 4262 904	CE04W1J4R7MT (SME)	4.7μF/63V
C801,802	254 4261 921	CE04W1H101MT (SME)	100μF/50V
C803,804	254 4260 948	CE04W1H010MT (SME)	1μF/50V
△ C805-808	254 4365 717	CE04W-682MC (DL)	6800μF/56V
C810	254 4180 950	CE04W1J2R2MT (SM)	2.2μF/63V
(Plastic Film)			
C501-504	255 6177 948	CQ09S1H101JT (SMT)	100pF/50V
C505,506	255 6178 963	CQ09S1H102JT (SMT)	1000pF/50V
C541,542	255 4199 973	CQ92M1H103JT (MRZ)	0.01μF/50V
(Metalized)			
C809	256 1042 903	CF93A2E104K	0.1μF/250V

Ref. No.	Part No.	Part Name	Remarks
OTHER PARTS			
	205 0190 036	3P NH CONN. BASE	TP001,002
	205 0233 032	3P EH CONN. BASE	
	205 0185 054	5P WIRE HOLDER	
	203 4705 007	3P EH-SCN CORD (RED)	CN3A
	203 8218 082	5P EH-CON CORD	CN5D
	204 0309 002	6P EH-SCN CONN. CORD	CN6A

1U-2029E P.AMP & SUPPLY UNIT PARTS LIST (for U.S.A. Black Version)

[Same as 1U-2029A (for Europe Black Version) except the followings]

Ref. No.	Part No.	Part Name	Remarks
RESISTORS			
(Carbon Film)			
△ R691-694	241 2314 049	RD14B2E100JNBF	10Ω, 1/4W (NB) ADE
CAPACITORS			
(Metalized)			
C525,526	256 1042 903	CF93A2E104K	0.1μF/250V CHANGE
C545,546	256 1042 903	CF93A2E104K	0.1μF/250V CHANGE
OTHER PARTS			
	203 8287 000	5P EH-SCN CONN. CORD	CN5D CHANGE
	204 0310 004	6P EH-SCN CONN. CORD	CN6A CHANGE
	205 0185 054	5P WIRE HOLDER	DELETE

ADDENDUM LIST PMA-1060

Ref. No.	Part Name & Descriptions	Part No.						
		Europe Black	Europe Gold	U.K Black	Australia Black	Multi-Voltage Black	U.S.A Black	Canada Black
⊙ 1	INPUT & CONTROL UNIT	1U-2030A	1U-2030B	1U-2030D	1U-2030D	1U-2030C	1U-2030E	1U-2030E
⊙ 2	P. AMP & SUPPLY UNIT	1U-2031A	1U-2031A	1U-2031A	1U-2031A	1U-2031C	1U-2031E	1U-2031F
55	POWER SWITCH UNIT	—	—	—	—	1U-2092C	1U-2092E	1U-2092E
⚠ 56	AC OUTLET (POLARIZED)	—	—	—	—	203 3926 007	203 3926 007	203 3926 007
57	PRESET LABEL	—	—	—	—	515 8030 008	—	—
⚠ 58	VOLTAGE SEL SWITCH	—	—	—	—	212 9555 007	—	—
60	8P SP TERMINAL	205 0471 001	205 0471 001	205 0467 002	205 0467 002	205 0467 002	205 0467 002	205 0467 002
⊙ 9	CORD HOLDER (L76)	445 0048 003 (1)	445 0048 003 (1)	445 0048 003 (1)	445 0048 003 (1)	445 0048 003 (1)	445 0048 003 (4)	445 0048 003 (4)
⊙ 12	BACK PANEL	105 0893 305	105 0893 305	105 0893 321	105 0893 321	105 0893 347	105 0893 363	105 0893 389
⚠ 15	AC CORD	206 2063 009	206 2063 009	206 2024 006	206 2025 005	206 2083 005	206 2060 002	206 2060 002
⊙ 16	UL TUBE (8.3)	415 0364 032	415 0364 032	415 0364 032	415 0364 032	—	—	—
⊙⚠ 17	CORD BUSH	445 0056 008	445 0056 008	445 0056 008	445 0056 008	445 0071 009	445 0056 008	445 0056 008
⊙ 18	MASKING SHEET BLIND SHEET	513 1144 005 —	513 1144 005 —	— —	— —	— —	— 513 9224 008	— —
22	C903,904 CK45B1H334K (330pF/50V)	253 1001 000	253 1001 000	253 1001 000	253 1001 000	—	—	—
31	PUSH KNOB	113 1356 004	113 1356 017	113 1356 004	113 1356 004	113 1356 004	113 1356 004	113 1356 004
34	FUJI KNOB Ass'y	112 0638 005	112 0638 018	112 0638 005	112 0638 005	112 0638 005	112 0638 005	112 0638 005
38	KNOB Ass'y	112 0632 205	112 0632 218	112 0632 205	112 0632 205	112 0632 205	112 0632 205	112 0632 205
⊙ 39	FRONT PANEL Ass'y	144 1991 104	144 1991 120	144 1991 104	144 1991 104	144 1991 104	144 1991 104	144 1991 104
⊙ 44	SIDE PLATE (L)	146 1140 003	146 1140 016	146 1140 003	146 1140 003	146 1140 003	146 1140 003	146 1140 003
⊙ 45	SIDE PLATE (R)	146 1141 002	146 1141 015	146 1141 002	146 1141 002	146 1141 002	146 1141 002	146 1141 002
⚠ 61	POWER SWITCH (SW801)	212 1031 008	212 1031 008	212 1031 008	212 1031 008	212 9534 002	212 9534 002	212 9534 002
⚠ 47	POWER TRANS	233 5810 002	233 5810 002	233 5811 001	233 5811 001	233 5812 000	233 5813 009	233 5813 009
48	P. KNOB (P) Ass'y	113 9213 000	113 9213 026	113 9213 000	113 9213 000	113 9213 000	113 9213 000	113 9213 000
49	VOLUME KNOB Ass'y	112 0537 009	112 0537 025	112 0537 009	112 0537 009	112 0537 009	112 0537 009	112 0537 009
50	KNOB Ass'y	112 0635 202	112 0635 215	112 0635 202	112 0635 202	112 0635 202	112 0635 202	112 0635 202
⊙ 54	TOP COVER	102 9027 102	102 9027 115	102 9027 102	102 9027 102	102 9027 102	102 9027 102	102 9027 102
59	HEADPHONE JACK	204 8354 004	204 8355 003	204 8354 004	204 8354 004	204 8354 004	204 8354 004	204 8354 004
⚠ 80	FUSE (F801)	206 1015 087 4.0A (250V)	206 1015 087 4.0A (250V)	206 1015 087 4.0A (250V)	206 1015 087 4.0A (250V)	206 1061 073 10A (250V)	206 1046 043 10A (125V)	206 1046 043 10A (125V)
⚠ 78	FUSE (F802,803)	206 1015 029 (250V) 1A	206 1015 029 (250V) 1A	206 1015 029 (250V) 1A	206 1015 029 (250V) 1A	206 1060 074 (250V) 1A	206 1039 034 (125V) 1A	206 1039 034 (125V) 1A
⚠	FUSE LABEL	—	—	—	—	—	513 1674 067	513 1674 067
⚠	FUSE (F804)	—	—	—	—	206 1061 044 5A (250V)	—	—
	DANGEROUS MARK COLOR LABEL (GOLD)	—	—	—	—	—	513 8266 009	513 8266 009
104	FIXING SCREW	477 0064 107 (6)	477 0064 107 (6)	477 0064 107 (6)	477 0064 107 (6)	477 0064 107 (8)	477 0064 107 (8)	477 0064 107 (8)
109	EARTH SCREW	477 0276 018 (2)	477 0276 018 (2)	477 0276 018 (2)	477 0276 018 (2)	—	—	—
111	3P SWELLING SCREW	477 0263 005 (6)	477 0263 018 (6)	477 0263 005 (6)	477 0263 005 (6)	477 0263 005 (6)	477 0263 005 (6)	477 0263 005 (6)

PARTS LIST OF EXPLODED VIEW
 (For PMA-860 Europe Black Version)

Ref. No.	Part No.	Part Name	Remarks	Q'ty	Ref. No.	Part No.	Part Name	Remarks	Q'ty
⊙ 1	See add. list	INPUT & CONTROL UNIT		1	62	212 1035 004	SLIDE SW (2-6) REMOTE	SW102	1
1-1	—	INPUT UNIT		1				INPUT	
1-2	—	CONTROL UNIT		1	63	212 4331 006	SLIDE SW (4-6) REMOTE	REC OUT	1
1-3	—	EQ. UNIT		1	64	212 1040 002	1P PUSH SWITCH	SW301	1
1-4	—	PROTECTOR & SP. UNIT		1				SOURCE DIRECT	
1-5	—	SPEAKER SWITCH UNIT		1	65	211 0656 009	V1620V20FB303T VOLUME	MAIN, 30KΩ	1
1-7	—	H/P UNIT		1	66	212 1041 001	1P PUSH SWITCH	SW701	1
1-8	—	POWER LED UNIT		1				MM-MC SW	
1-9	—	S.D. LED UNIT		1	67	212 0322 006	ROTARY SWITCH	SPEAKER	1
1-11	—	BASS UNIT		1	68	211 0653 015	V1620P30FD303K VOLUME	BASS	1
⊙ 2	See add. list	P. AMP & SUPPLY UNIT		1	69	211 0653 002	V1620P30FD103K VOLUME	TREBLE	1
⊙ 3	411 0950 208	FRONT CHASSIS		1	70	211 0654 001	V1620P30FW104K VOLUME	BALANCE	1
⊙ 4	412 3087 003	P.W.B. BRACKET		1	71	212 1038 001	2P PUSH SWITCH	SUB, LOUD	1
⊙ 5	411 9056 349	TRANS CHASSIS		1	72	204 8300 003	6P PIN JACK		1
⊙ 6	412 2994 003	TRANS BRACKET		1	73	204 8266 008	4P PIN JACK (S-GND)		2
⊙ 7	415 9032 006	P.C.B. HOLDER (T)		2	74	205 0274 004	2P CONNECTOR BASE		1
8	—	—		1	75	—	—		—
⊙ 9	See add. list	CORD HOLDER (L76)		1	76	393 9155 007	SLP-171E (LED)	POWER	1
⊙ 10	411 9057 500	SIDE CHASSIS		1	77	393 9420 907	SEL4117R (LED)	SOURCE DIRECT	1
⊙ 11	412 2991 103	RADIATOR BRACKET (B)		2					
⊙ 12	See add. list	BACK PANEL		1	78	—	—		—
13	477 0018 001	WASHER (P-87)		1	79	254 4365 717	CE04W==682MC (DL)	C805-808	4
14	205 0071 016	TERMINAL ASS'Y		1	80	See add. list	FUSE	F801	1
⚠ 15	See add. list	AC CORD		1					
⊙ 16	See add. list	UL TUBE (8.3)		1					
⊙ 17	See add. list	CORD BUSH		1					
⊙ 18	See add. list	MASKING SHEET		1					
⊙ 19	412 2814 028	CARD SPACER (L=10)		2					
⊙ 20	412 3088 002	VOLUME BRACKET		1					
⊙ 21	412 3089 001	SUPPORT BRACKET		1					
22	—	—							
⊙ 23	417 0394 105	POWER RADIATOR		2					
24	273 0386 018	2SC3854LB (O/P/Y) (Z)	TR523,524,	4					
			TR527,528						
25	271 0237 019	2SA1490LB (O/P/Y) (Z)	TR525,526,	4					
			TR529,530						
26	415 0234 007	INSULATING SHEET		8					
⊙ 27	412 2814 015	CARD SPACER (L=14)		2					
28	212 0320 008	ROTARY REMOTE SWITCH	INPUT	1					
29	212 0321 007	ROTARY REMOTE SWITCH	REC OUT	1					
30	—	—							
31	See add. list	PUSH KNOB		4					
32	113 1337 007	PUSH KNOB JOINT		1					
33	113 1366 007	PUSH KNOB JOINT (B)		1					
34	See add. list	FUJI KNOB		1					
⊙ 35	112 0642 208	VR KNOB JOINT (A)		1					
⊙ 36	112 0643 003	VR KNOB JOINT (B)		1					
⊙ 37	112 0659 000	VR JOINT STOPPER		1					
38	See add. list	MARU KNOB (S)		3					
⊙ 39	See add. list	FRONT PANEL ASS'Y		1					
⊙ 40	412 2549 021	BRACKET (C)		1					
⊙ 41	412 2549 034	BRACKET (D)		1					
⊙ 42	105 0894 100	BOTTOM COVER		1					
⊙ 43	104 0194 001	FOOT ASS'Y		4					
⊙ 44	See add. list	SIDE PLATE (L)		1					
⊙ 45	See add. list	SIDE PLATE (R)		1					
46	—	—							
⚠ 47	See add. list	POWER TRANS (E2)		1					
48	See add. list	P. KNOB (P) ASS'Y		1					
49	See add. list	VOLUME KNOB ASS'Y		1					
50	See add. list	KNOB ASS'Y		2					
⊙ 51	445 8004 007	WIRE CLAMPER		8					
⊙ 52	461 0501 005	RUBBER SHEET		2					
⊙ 53	461 0334 007	RUBBER SHEET		2					
⊙ 54	See add. list	TOP COVER		1					
55	See add. list	POWER SWITCH UNIT		1					
59	See add. list	HEADPHONE JACK		1					
60	See add. list	8P SP TERMINAL		1					
61	See add. list	POWER SWITCH		1					

SCREWS									
101	473 7015 018	TAPPING SCREW (S) 3x8 (BLACK)		46					
102	473 7004 003	TAPPING SCREW (S) 4x8		4					
103	—	—		—					
104	—	—		—					
105	473 7002 018	TAPPING SCREW (S) 3x8		12					
106	473 8007 009	3x12 CUP SCREW		8					
107	473 3806 014	TAPPING SCREW (2) 3x8		1					
108	473 7501 001	TAPPING SCREW (P) 3x10		2					
109	—	—		—					
110	473 7003 004	TAPPING SCREW (S) 3x8		4					
111	See add. list	3P SWELLING SCREW		6					

PACKING & ACCESSORIES (not included EXPLODED VIEW)									
⊙ 201	511 1956 006	INST. MANUAL (E2/EK)		1					
⊙ 202	504 9102 003	STYRENE PAPER		1					
⊙ 203	505 9102 019	POLY COVER		1					
⊙ 204	504 0092 060	STYRENE PAPER		1					
⊙ 205	503 0864 004	CUSHION		2					
⊙ 206	502 0741 030	PAD		1			170x110xT50		
⊙ 207	501 1431 032	CARTON CASE		1			K280xSK280		
⊙ 208	513 1389 006	CONTROL CARD BASE		1					
⊙ 209	513 1349 004	THERMAL CARBON FILM		1					

ADDENDUM LIST PMA-860

Ref. No.	Part Name & Description	Part No.						
		Europe Black	Europe Gold	U.K Black	Australia Black	Multi-Voltage Black	U.S.A Black	Canada Black
⊙ 1	INPUT & CONTROL UNIT	1U- 2028 A	1U- 2028 B	1U- 2028 D	1U- 2028 D	1U- 2028 C	1U- 2028 C	1U- 2028 C
⊙ 2	P. AMP & SUPPLY UNIT	1U- 2029 A	1U- 2029 A	1U- 2029 A	1U- 2029 A	1U- 2029 A	1U- 2029 E	1U- 2029 F
55	POWER SWITCH UNIT	—	—	—	—	1U- 2091 C	1U- 2091 E	1U- 2091 E
⚠ 56	AC OUTLET (POLARIZED)	—	—	—	—	203 3926 007	203 3926 007	203 3926 007
57	PRESET LABEL	—	—	—	—	515 8030 008	—	—
⚠ 58	VOLTAGE SEL SWITCH	—	—	—	—	212 9555 007	—	—
⚠ 80	FUSE (F-801)	206 1015 074 3.15A (250V)	206 1015 074 3.15A (250V)	206 1015 074 3.15A (250V)	206 1015 074 3.15A (250V)	206 1061 060 8A (250V)	206 1046 014 8A (125V)	206 1046 014 8A (125V)
⚠	FUSE (F-804)	—	—	—	—	206 1061 031 4A (250V)	—	—
⊙ 12	BACK PANEL	105 0893 318	105 0893 318	105 0893 334	105 0893 334	105 0893 350	105 0893 376	105 0893 392
⚠ 15	AC CORD	206 2063 009	206 2063 009	206 2024 006	206 2025 005	206 2083 005	206 2060 002	206 2060 002
⊙ 16	UL TUBE (8.3)	415 0364 032	415 0364 032	415 0364 032	415 0364 032	—	—	—
⊙ 17	CORD BUSH	445 0056 008	445 0056 008	445 0056 008	445 0056 008	445 0071 009	445 0056 008	445 0056 008
⊙ 18	MASKING SHEET	513 1144 005	513 1144 005	—	—	—	—	—
	BLIND SHEET	—	—	—	—	—	513 9224 008	—
22								
31	PUSH KNOB	113 1356 004	113 1356 017	113 1356 004	113 1356 004	113 1356 004	113 1356 004	113 1356 004
34	FUJI KNOB	112 0641 005	112 0641 018	112 0641 005	112 0641 005	112 0641 005	112 0641 005	112 0641 005
38	MARU KNOB(S)	112 0646 000	112 0646 013	112 0646 000	112 0646 000	112 0646 000	112 0646 000	112 0646 000
⊙ 39	FRONT PANEL Ass'y	144 1991 214	144 1991 133	144 1991 214	144 1991 214	144 1991 214	144 1991 214	144 1991 214
⊙ 44	SIDE PLATE (L)	146 1140 003	146 1140 016	146 1140 003	146 1140 003	146 1140 003	146 1140 003	146 1140 003
⊙ 45	SIDE PLATE (R)	146 1141 002	146 1141 015	146 1141 002	146 1141 002	146 1141 002	146 1141 002	146 1141 002
⚠ 61	POWER SWITCH (SW801)	212 1031 008	212 1031 008	212 1031 008	212 1031 008	212 9534 002	212 9534 002	212 9534 002
⚠ 47	POWER TRANS	233 5806 003	233 5806 003	233 5807 002	233 5807 002	233 5808 001	233 5809 000	233 5809 000
48	P. KNOB (P) Ass'y	113 9213 000	113 9213 026	113 9213 000	113 9213 000	113 9213 000	113 9213 000	113 9213 000
49	VOLUME KNOB Ass'y	112 0537 009	112 0537 025	112 0537 009	112 0537 009	112 0537 009	112 0537 009	112 0537 009
50	KNOB Ass'y	112 0635 202	112 0635 215	112 0635 202	112 0635 202	112 0635 202	112 0635 202	112 0635 202
⊙ 54	TOP COVER	102 9027 102	102 9027 115	102 9027 102	102 9027 102	102 9027 102	102 9027 102	102 9027 102
59	HEADPHONE JACK	204 8354 004	204 8355 003	204 8354 004	204 8354 004	204 8354 004	204 8354 004	204 8354 004
60	8P SP TERMINAL	205 0484 001	205 0484 001	205 0472 013	205 0472 013	205 0472 000	205 0472 000	205 0472 000
	DANGEROUS MARK COLOR LABEL (GOLD)	—	—	—	—	—	513 8266 009	513 8266 009
		—	513 9111 001	—	—	—	—	—
111	3P SWELLING SCREW	477 0263 005 (6)	477 0263 018 (6)	477 0263 005 (6)	477 0263 005 (6)	477 0263 005 (6)	477 0263 005 (6)	477 0263 005 (6)
⊙ 9	CORD HOLDER (L76)	—	—	—	—	—	445 0048 003 (1)	445 0048 003 (1)

EXPLODED VIEW OF CHASSIS AND CABINET

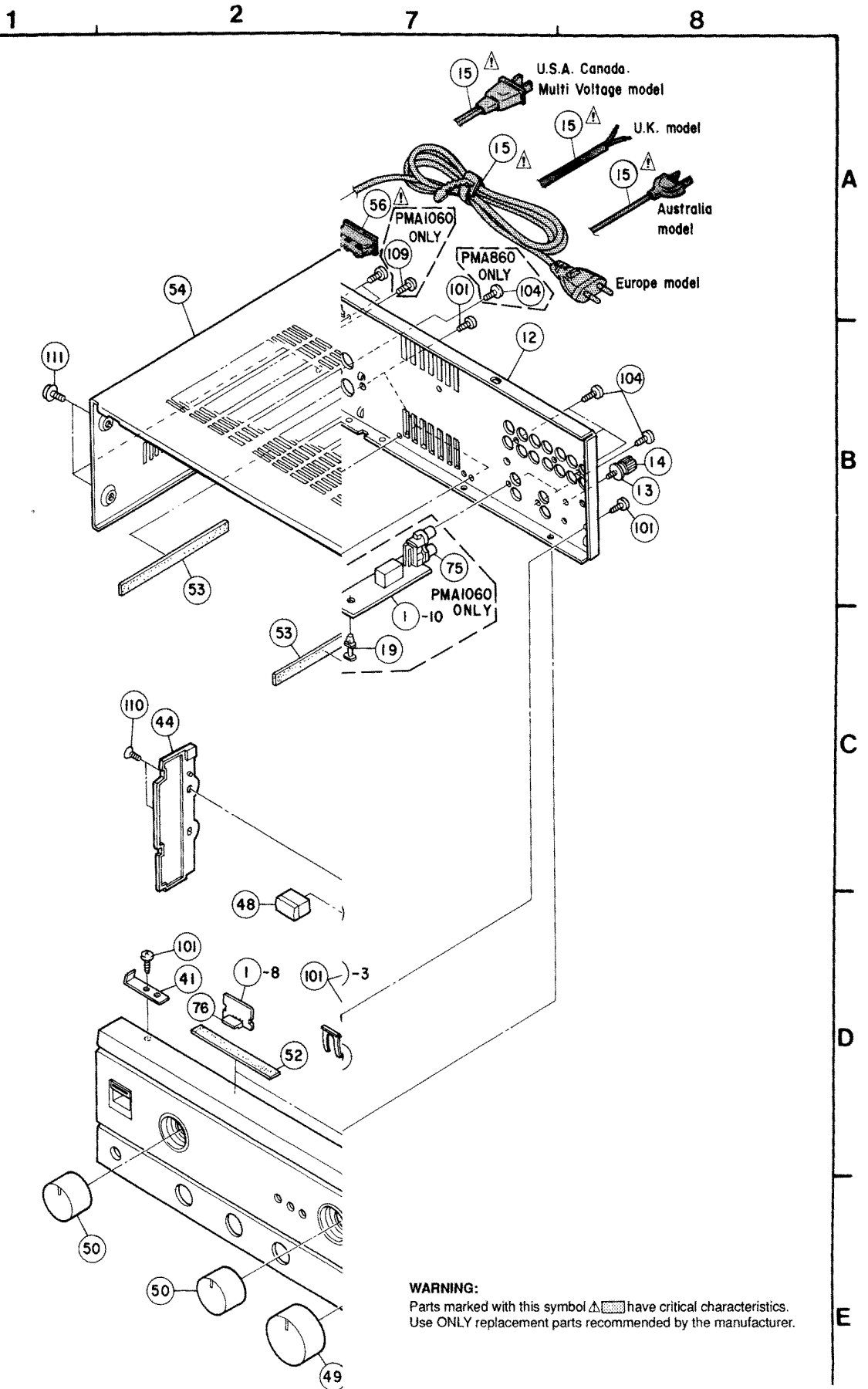

WARNING:
 Parts marked with this symbol  have critical characteristics.
 Use ONLY replacement parts recommended by the manufacturer.

A
B
C
D
E

(U.S. & CANADA MODEL ONLY)

(OTHERS)

(PMA-1060 ONLY)

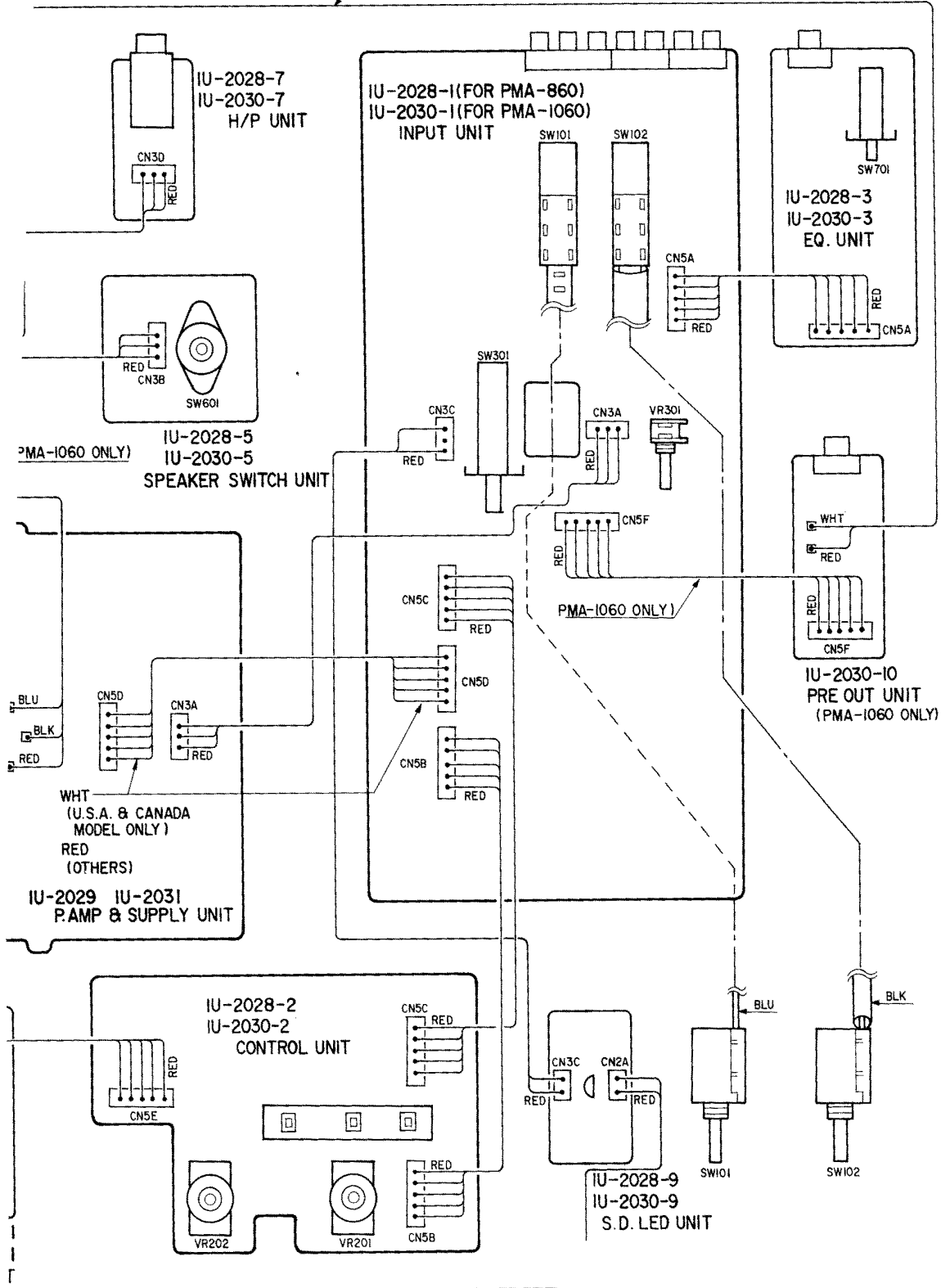

IU-2031
P. AMP & SUPPLY UNIT

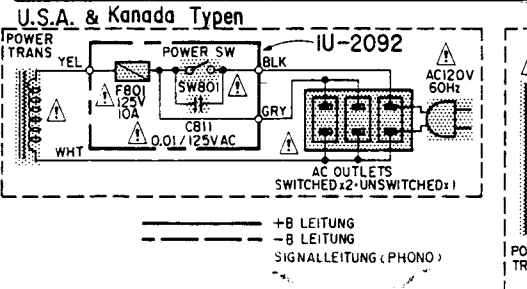
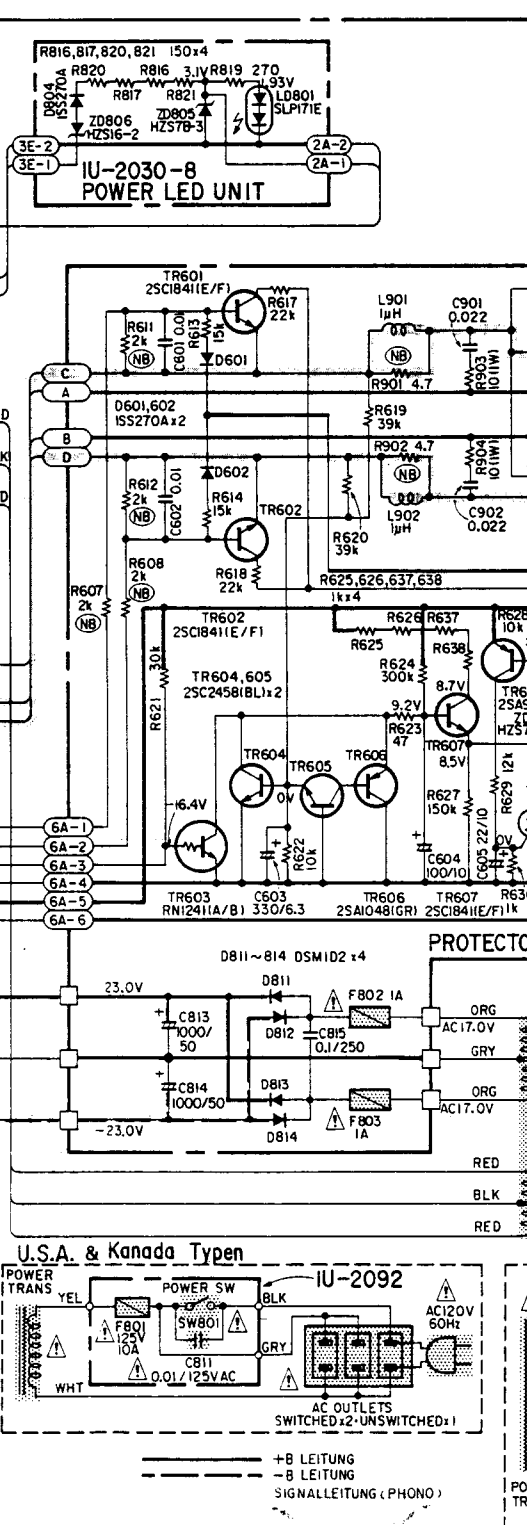
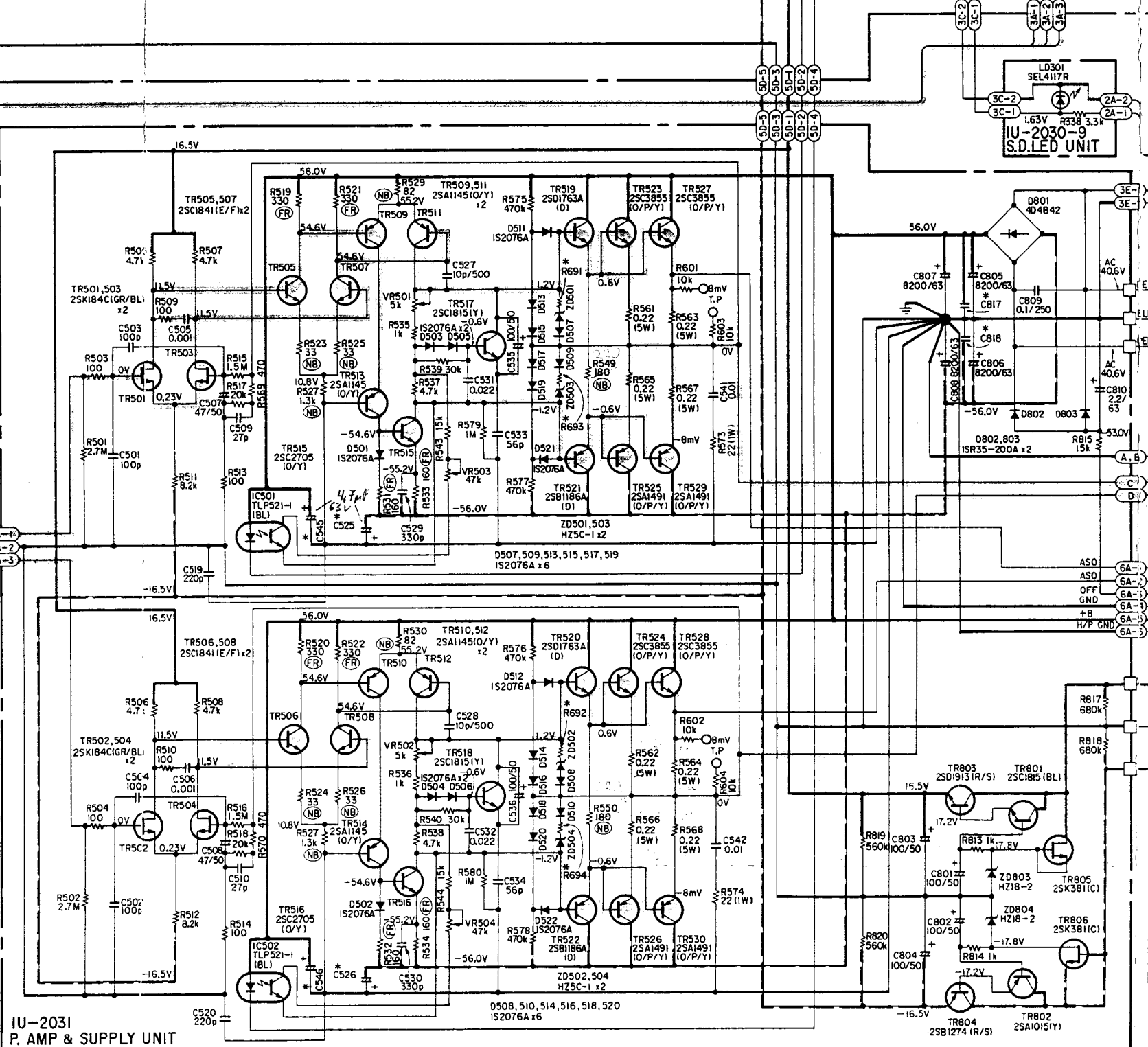

+B LEITUNG
-B LEITUNG
SIGNALLEITUNG (PHONO)

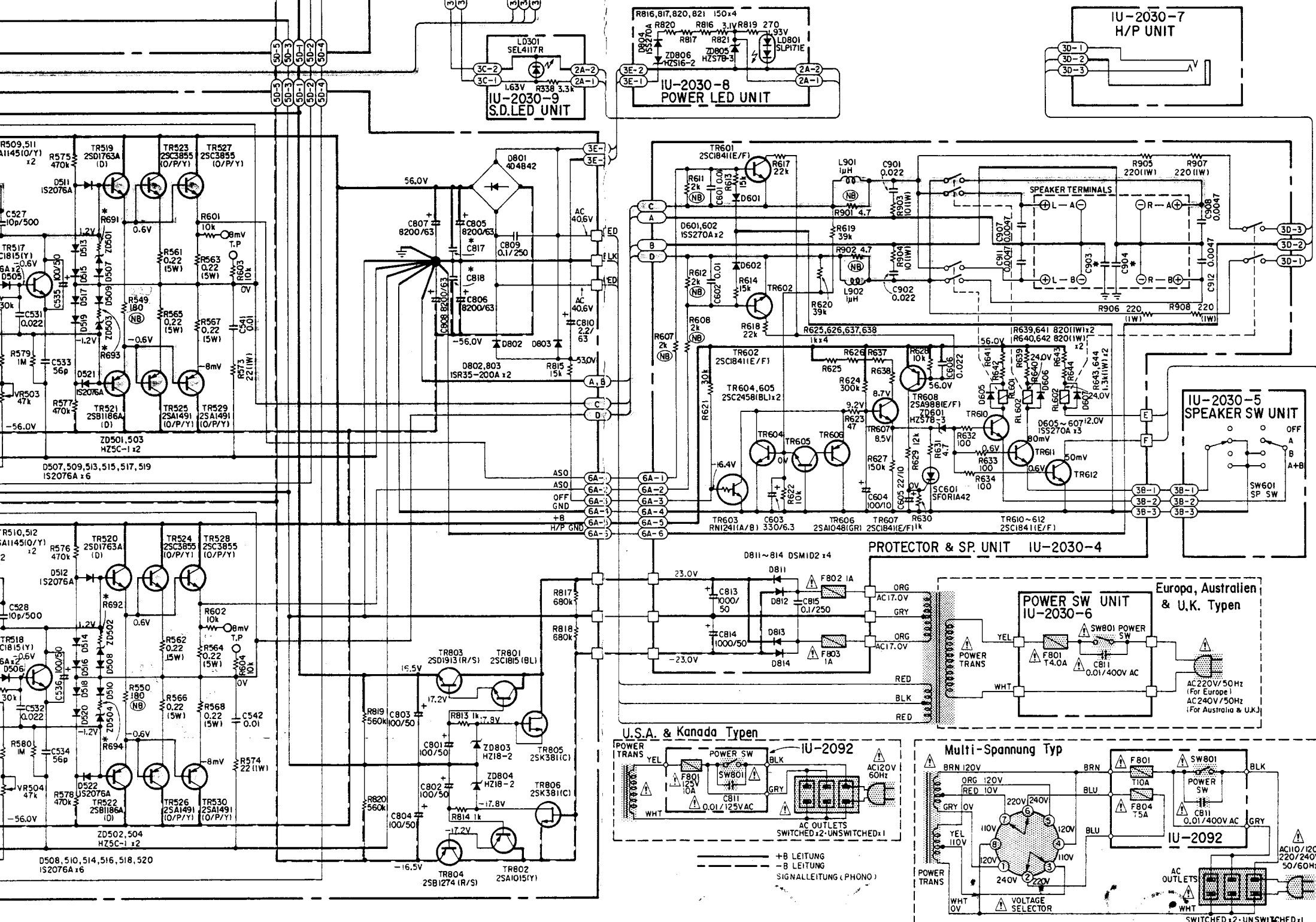

2SA 1145 = 2SA 1124